

**FIRST AMENDED**  
**LARGE GENERATOR INTERCONNECTION AGREEMENT (LGIA)**  
**AMONG**

**NEXTERA BLYTHE SOLAR ENERGY CENTER, LLC**  
**AND**

**SOUTHERN CALIFORNIA EDISON COMPANY**  
**AND**

**CALIFORNIA INDEPENDENT SYSTEM OPERATOR CORPORATION**

**Dracker Project TOT276 (Q294)**

## TABLE OF CONTENTS

FIRST AMENDED LARGE GENERATOR INTERCONNECTION AGREEMENT .....	10
ARTICLE 1. DEFINITIONS .....	11
ARTICLE 2. EFFECTIVE DATE, TERM AND TERMINATION.....	19
2.1    Effective Date. ....	19
2.2    Term of Agreement.....	20
2.3    Termination Procedures.....	20
2.3.1    Written Notice.....	20
2.3.2    Default.....	20
2.3.3    Suspension of Work. ....	20
2.3.4    .....	20
2.3.5    Partial Termination. ....	20
2.4    Termination Costs.....	20
2.4.1    .....	22
2.4.2    .....	22
2.4.3    .....	22
2.4.4    .....	22
2.5    Disconnection. ....	25
2.6    Survival.....	25
ARTICLE 3. REGULATORY FILINGS AND CAISO TARIFF COMPLIANCE .....	25
3.1    Filing.....	25
3.2    Agreement Subject to CAISO Tariff. ....	25
3.3    Relationship Between this LGIA and the CAISO Tariff. ....	25
3.4    Relationship Between this LGIA and the QF PGA. ....	26
ARTICLE 4. SCOPE OF SERVICE .....	26
4.1    Interconnection Service. ....	26
4.2    Provision of Service.....	26
4.3    Performance Standards.....	26
4.4    No Transmission Service.....	26
4.5    Interconnection Customer Provided Services.....	27
ARTICLE 5. INTERCONNECTION FACILITIES ENGINEERING, PROCUREMENT, AND CONSTRUCTION.....	27
5.1    Options. ....	27
5.1.1    Standard Option. ....	27
5.1.2    Alternate Option. ....	27
5.1.3    Option to Build.....	28
5.1.4    Negotiated Option.....	28
5.2    General Conditions Applicable to Option to Build. ....	29
5.3    Liquidated Damages.....	30
5.4    Power System Stabilizers. ....	32

5.5	Equipment Procurement. ....	32
5.5.1	.....	32
5.5.2	.....	32
5.5.3	.....	32
5.6	Construction Commencement. ....	32
5.6.1	.....	32
5.6.2	.....	33
5.6.3	.....	33
5.6.4	.....	33
5.7	Work Progress. ....	33
5.8	Information Exchange. ....	33
5.9	Limited Operation. ....	33
5.10	Interconnection Customer's Interconnection Facilities. ....	33
5.10.1	Large Generating Facility and Interconnection Customer's Interconnection Facilities Specifications. ....	34
5.10.2	Participating TO's and CAISO's Review. ....	34
5.10.3	Interconnection Customer's Interconnection Facilities Construction. .	34
5.10.4	Interconnection Customer to Meet Requirements of the Participating TO's Interconnection Handbook. ....	35
5.11	Participating TO's Interconnection Facilities Construction. ....	35
5.12	Access Rights. ....	35
5.13	Lands of Other Property Owners. ....	36
5.14	Permits.....	36
5.15	Early Construction of Base Case Facilities. ....	36
5.16	Suspension.....	36
5.17	Taxes. ....	37
5.17.1	Interconnection Customer Payments Not Taxable. ....	37
5.17.2	Representations And Covenants. ....	37
5.17.3	Indemnification for the Cost Consequence of Current Tax Liability Imposed Upon the Participating TO.....	38
5.17.4	Tax Gross-Up Amount. ....	39
5.17.5	Private Letter Ruling or Change or Clarification of Law. ....	40
5.17.6	Subsequent Taxable Events.....	40
5.17.7	Contests. ....	40
5.17.8	Refund.....	41
5.17.9	Taxes Other Than Income Taxes. ....	42
5.18	Tax Status.....	43
5.19	Modification.....	43
5.19.2	Standards. ....	44
5.19.3	Modification Costs. ....	44
ARTICLE 6. TESTING AND INSPECTION .....		44
6.1	Pre-Commercial Operation Date Testing and Modifications. ....	44
6.2	Post-Commercial Operation Date Testing and Modifications.....	44

6.3	Right to Observe Testing .....	45
6.4	Right to Inspect.....	45
ARTICLE 7.	METERING .....	45
7.1	General.....	45
7.2	Check Meters.....	46
7.3	Participating TO Retail Metering.....	46
ARTICLE 8.	COMMUNICATIONS.....	46
8.1	Interconnection Customer Obligations.....	46
8.2	Remote Terminal Unit.....	46
8.3	No Annexation.....	47
ARTICLE 9.	OPERATIONS.....	47
9.1	General.....	47
9.2	Balancing Authority Area Notification.....	47
9.3	CAISO and Participating TO Obligations.....	47
9.4	Interconnection Customer Obligations.....	48
9.5	Start-Up and Synchronization.....	48
9.6	Reactive Power.....	48
9.6.1	Power Factor Design Criteria.....	48
9.6.2	Voltage Schedules.....	48
9.6.3	Payment for Reactive Power .....	50
9.7	Outages and Interruptions.....	50
9.7.1	Outages.....	50
9.7.2	Interruption of Service.....	51
9.7.3	Under-Frequency and Over Frequency Conditions.....	52
9.7.4	System Protection and Other Control Requirements.....	52
9.7.5	Requirements for Protection.....	53
9.7.6	Power Quality.....	54
9.8	Switching and Tagging Rules.....	54
9.9	Use of Interconnection Facilities by Third Parties.....	54
9.9.1	Purpose of Interconnection Facilities.....	54
9.9.2	Third Party Users.....	55
9.10	Disturbance Analysis Data Exchange.....	55
ARTICLE 10.	MAINTENANCE .....	55
10.1	Participating TO Obligations.....	55
10.2	Interconnection Customer Obligations.....	55
10.3	Coordination.....	55
10.4	Secondary Systems.....	55
10.5	Operating and Maintenance Expenses.....	56
ARTICLE 11.	PERFORMANCE OBLIGATION .....	56
11.1	Interconnection Customer's Interconnection Facilities.....	56

11.2	Participating TO's Interconnection Facilities. ....	56
11.3	Network Upgrades and Distribution Upgrades.....	56
11.4	Transmission Credits. ....	56
11.4.1	Repayment of Amounts Advanced for Network Upgrades. ....	57
11.4.2	Special Provisions for Affected Systems. ....	57
11.4.3	.....	58
11.5	Provision of Interconnection Financial Security. ....	58
11.6	Interconnection Customer Compensation.....	58
11.6.1	Interconnection Customer Compensation for Actions During Emergency Condition. ....	58
ARTICLE 12. INVOICE .....		58
12.1	General.....	59
12.2	Final Invoice.....	59
12.3	Payment.....	59
12.4	Disputes.....	60
ARTICLE 13. EMERGENCIES.....		60
13.1	[Reserved] .....	60
13.2	Obligations.....	60
13.3	Notice.....	60
13.4	Immediate Action. ....	61
13.5	CAISO and Participating TO Authority.....	61
13.5.1	General.....	61
13.5.2	Reduction and Disconnection.....	61
13.6	Interconnection Customer Authority.....	62
13.7	Limited Liability. ....	62
ARTICLE 14. REGULATORY REQUIREMENTS AND GOVERNING LAW.....		62
14.1	Regulatory Requirements. ....	62
14.2	Governing Law.....	63
14.2.1	.....	63
14.2.2	.....	63
14.2.3	.....	63
ARTICLE 15. NOTICES .....		63
15.1	General.....	63
15.2	Billings and Payments.....	63
15.3	Alternative Forms of Notice.....	63
15.4	Operations and Maintenance Notice.....	63
ARTICLE 16. FORCE MAJEURE.....		64
16.1	Force Majeure.....	64
16.1.1	.....	64
16.1.2	.....	64

ARTICLE 17. DEFAULT.....	64
17.1    Default.....	64
17.1.1    General.....	64
17.1.2    Right to Terminate.....	64
ARTICLE 18. INDEMNITY, CONSEQUENTIAL DAMAGES AND INSURANCE .....	65
18.1    Indemnity.....	65
18.1.1    Indemnified Party.....	65
18.1.2    Indemnifying Party.....	65
18.1.3    Indemnity Procedures.....	65
18.2    Consequential Damages.....	66
18.3    Insurance.....	66
18.3.1 .....	66
18.3.2 .....	66
18.3.3 .....	67
18.3.4 .....	67
18.3.5 .....	67
18.3.6 .....	67
18.3.7 .....	67
18.3.8 .....	68
18.3.9 .....	68
18.3.10 .....	68
18.3.11 .....	68
ARTICLE 19. ASSIGNMENT .....	68
19.1    Assignment.....	68
ARTICLE 20. SEVERABILITY.....	69
20.1    Severability.....	69
ARTICLE 21. COMPARABILITY .....	69
21.1    Comparability.....	69
ARTICLE 22. CONFIDENTIALITY .....	69
22.1    Confidentiality.....	69
22.1.1    Term.....	70
22.1.2    Scope.....	70
22.1.3    Release of Confidential Information.....	70
22.1.4    Rights.....	71
22.1.5    No Warranties.....	71
22.1.6    Standard of Care.....	71
22.1.7    Order of Disclosure.....	71
22.1.8    Termination of Agreement.....	71
22.1.9    Remedies.....	71
22.1.10    Disclosure to FERC, its Staff, or a State.....	72
22.1.11 .....	72
ARTICLE 23. ENVIRONMENTAL RELEASES .....	73
23.1    73	

ARTICLE 24. INFORMATION REQUIREMENTS .....	73
24.1 Information Acquisition.....	73
24.2 Information Submission by Participating TO.....	73
24.3 Updated Information Submission by Interconnection Customer. ....	73
24.4 Information Supplementation. ....	74
ARTICLE 25. INFORMATION ACCESS AND AUDIT RIGHTS.....	75
25.1 Information Access. ....	75
25.2 Reporting of Non-Force Majeure Events.....	75
25.3 Audit Rights .....	75
25.3.1 .....	75
25.3.2 .....	76
25.4 Audit Rights Periods. ....	76
25.4.1 Audit Rights Period for Construction-Related Accounts and Records.	76
25.4.2 Audit Rights Period for All Other Accounts and Records.....	76
25.5 Audit Results.....	76
25.5.1 .....	77
ARTICLE 26. SUBCONTRACTORS .....	77
26.1 General.....	77
26.2 Responsibility of Principal.....	77
26.3 No Limitation by Insurance.....	77
ARTICLE 27. DISPUTES .....	77
27.1 Submission.....	77
27.2 External Arbitration Procedures.....	78
27.3 Arbitration Decisions.....	78
27.4 Costs.....	78
ARTICLE 28. REPRESENTATIONS, WARRANTIES AND COVENANTS .....	78
28.1 General.....	79
28.1.1 Good Standing .....	79
28.1.2 Authority .....	79
28.1.3 No Conflict.....	79
28.1.4 Consent and Approval.....	79
ARTICLE 29. [RESERVED] .....	79
ARTICLE 30. MISCELLANEOUS.....	79
30.1 Binding Effect.....	80
30.2 Conflicts.....	80
30.3 Rules of Interpretation.....	80
30.4 Entire Agreement.....	80
30.5 No Third Party Beneficiaries.....	80
30.6 Waiver.....	81
30.7 Headings.....	81

30.8	Multiple Counterparts.....	81
30.9	Amendment. ....	81
30.10	Modification by the Parties.....	81
30.11	Reservation of Rights.....	81
30.12	No Partnership.....	82
30.13	Joint and Several Obligations .....	82
Appendix A	.....	85
Appendix B	.....	126
Appendix C	.....	133
Appendix D	.....	145
Appendix E	.....	146
Appendix F	.....	147
Appendix G	.....	149
Appendix H	.....	150
Appendix I	.....	153



**Appendices  
To First Amended LGIA**

- Appendix A Interconnection Facilities, Network Upgrades and Distribution Upgrades
- Appendix B Milestones
- Appendix C Interconnection Details
- Appendix D Security Arrangements Details
- Appendix E Commercial Operation Date
- Appendix F Addresses for Delivery of Notices and Billings
- Appendix G Interconnection Customer's Proportional Share of Costs of Network Upgrades for Applicable Project Group
- Appendix H Interconnection Requirements for an Asynchronous Generating Facility Wind Generating Plant
- Appendix I Consent to Assignment

**FIRST AMENDED**

**LARGE GENERATOR INTERCONNECTION AGREEMENT**

**NEXTERA BLYTHE SOLAR ENERGY CENTER, LLC**

**SOUTHERN CALIFORNIA EDISON COMPANY**

**CALIFORNIA INDEPENDENT SYSTEM OPERATOR CORPORATION**

**THIS FIRST AMENDED LARGE GENERATOR INTERCONNECTION AGREEMENT** (“LGIA”) is made and entered into this \_\_\_\_ day of \_\_\_\_\_ 2016, by and among NextEra Blythe Solar Energy Center, LLC, a limited liability company organized and existing under the laws of the State of Delaware (“**Interconnection Customer**”), Southern California Edison Company, a corporation organized and existing under the laws of the State of California (“**Participating TO**”), and California Independent System Operator Corporation, a California nonprofit public benefit corporation organized and existing under the laws of the State of California (“**CAISO**”). Interconnection Customer, Participating TO, and CAISO each may be referred to as a “Party” or collectively as the “Parties.”

**RECITALS**

**WHEREAS**, CAISO exercises Operational Control over the CAISO Controlled Grid; and

**WHEREAS**, the Participating TO owns, operates, and maintains the Participating TO’s Transmission System; and

**WHEREAS**, Interconnection Customer (or Affiliates thereof) intends to own, lease and/or control and operate the Generating Facility identified as a Large Generating Facility in Appendix C to this LGIA; and

**WHEREAS**, Interconnection Customer, Participating TO, and CAISO have agreed to enter into this LGIA for the purpose of interconnecting the Large Generating Facility with the Participating TO’s Transmission System;

**NOW, THEREFORE**, in consideration of and subject to the mutual covenants contained herein, it is agreed:

When used in this LGIA, terms with initial capitalization that are not defined in Article 1 shall have the meanings specified in the Article in which they are used.

## ARTICLE 1. DEFINITIONS

**Abandoned Plant Approval** shall mean a FERC final order, not subject to rehearing or appeal, unconditionally granting the Participating TO's request for a declaratory order that the Participating TO can recover 100% of its prudently incurred costs for the Network Upgrades if such facilities are abandoned due to circumstances outside the Participating TO's control.

**Adverse System Impact** shall mean the negative effects due to technical or operational limits on conductors or equipment being exceeded that may compromise the safety and reliability of the electric system.

**Affected System** shall mean an electric system other than the CAISO Controlled Grid that may be affected by the proposed interconnection, including the Participating TO's electric system that is not part of the CAISO Controlled Grid.

**Affiliate** shall mean, with respect to a corporation, partnership or other entity, each such other corporation, partnership or other entity that directly or indirectly, through one or more intermediaries, controls, is controlled by, or is under common control with, such corporation, partnership or other entity.

**Applicable Laws and Regulations** shall mean all duly promulgated applicable federal, state and local laws, regulations, rules, ordinances, codes, decrees, judgments, directives, or judicial or administrative orders, permits and other duly authorized actions of any Governmental Authority.

**Applicable Reliability Council** shall mean the Western Electricity Coordinating Council or its successor.

**Applicable Reliability Standards** shall mean the requirements and guidelines of NERC, the Applicable Reliability Council, and the Balancing Authority Area of the Participating TO's Transmission System to which the Generating Facility is directly connected, including requirements adopted pursuant to Section 215 of the Federal Power Act.

**Asynchronous Generating Facility** shall mean an induction, doubly-fed, or electronic power generating unit(s) that produces 60 Hz (nominal) alternating current.

**Balancing Authority** shall mean the responsible entity that integrates resource plans ahead of time, maintains load-interchange-generation balance within a Balancing Authority Area, and supports Interconnection frequency in real time.

**Balancing Authority Area** shall mean the collection of generation, transmission, and loads within the metered boundaries of the Balancing Authority. The Balancing Authority maintains load-resource balance within this area.

**Base Case** shall mean the base case power flow, short circuit, and stability data bases used for the Interconnection Studies.

**Breach** shall mean the failure of a Party to perform or observe any material term or condition of this LGIA.

**Breaching Party** shall mean a Party that is in Breach of this LGIA.

**Business Day** shall mean Monday through Friday, excluding federal holidays and the day after Thanksgiving Day.

**CAISO Controlled Grid** shall mean the system of transmission lines and associated facilities of the parties to the Transmission Control Agreement that have been placed under the CAISO's Operational Control.

**CAISO Tariff** shall mean the CAISO's tariff, as filed with FERC, and as amended or supplemented from time to time, or any successor tariff.

**Calendar Day** shall mean any day including Saturday, Sunday or a federal holiday.

**Commercial Operation** shall mean the status of an Electric Generating Unit or project phase at a Generating Facility that has commenced generating electricity for sale, excluding electricity generated during Trial Operation.

**Commercial Operation Date** of an Electric Generating Unit or project phase shall mean the date on which the Electric Generating Unit or project phase at the Generating Facility commences Commercial Operation as agreed to by the applicable Participating TO, the CAISO, and the Interconnection Customer pursuant to Appendix E to this LGIA, and in accordance with the implementation plan agreed to by the Participating TO and the CAISO for multiple individual Electric Generating Units or project phases at a Generating Facility where an Interconnection Customer intends to establish separate Commercial Operation Dates for those Electric Generating Units or project phases.

**Confidential Information** shall mean any confidential, proprietary or trade secret information of a plan, specification, pattern, procedure, design, device, list, concept, policy or compilation relating to the present or planned business of a Party, which is designated as confidential by the Party supplying the information, whether conveyed orally, electronically, in writing, through inspection, or otherwise, subject to Article 22.1.2.

**Default** shall mean the failure of a Breaching Party to cure its Breach in accordance with Article 17 of this LGIA.

**Distribution System** shall mean those non-CAISO-controlled transmission and distribution facilities owned by the Participating TO.

**Distribution Upgrades** shall mean the additions, modifications, and upgrades to the Participating TO's Distribution System. Distribution Upgrades do not include Interconnection Facilities.

**Effective Date** shall mean the date on which this LGIA becomes effective upon execution by all Parties subject to acceptance by FERC, or if filed unexecuted, upon the date specified by FERC.

**Electric Generating Unit** shall mean an individual electric generator and its associated plant and apparatus whose electrical output is capable of being separately identified and metered.

**Emergency Condition** shall mean a condition or situation: (1) that in the judgment of the Party making the claim is imminently likely to endanger life or property; or (2) that, in the case of the CAISO, is imminently likely (as determined in a non-discriminatory manner) to cause a material adverse effect on the security of, or damage to, the CAISO Controlled Grid or the electric systems of others to which the CAISO Controlled Grid is directly connected; (3) that, in the case of the Participating TO, is imminently likely (as determined in a non-discriminatory manner) to cause a material adverse effect on the security of, or damage to, the Participating TO's Transmission System, Participating TO's Interconnection Facilities, Distribution System, or the electric systems of others to which the Participating TO's electric system is directly connected; or (4) that, in the case of the Interconnection Customer, is imminently likely (as determined in a non-discriminatory manner) to cause a material adverse effect on the security of, or damage to, the Generating Facility or Interconnection Customer's Interconnection Facilities. System restoration and black start shall be considered Emergency Conditions; provided, that Interconnection Customer is not obligated by this LGIA to possess black start capability.

**Environmental Law** shall mean Applicable Laws or Regulations relating to pollution or protection of the environment or natural resources.

**Federal Power Act** shall mean the Federal Power Act, as amended, 16 U.S.C. §§ 791a et seq.

**FERC** shall mean the Federal Energy Regulatory Commission or its successor.

**Force Majeure** shall mean any act of God, labor disturbance, act of the public enemy, war, insurrection, riot, fire, storm or flood, explosion, breakage or accident to machinery or equipment, any order, regulation or restriction imposed by governmental,

military or lawfully established civilian authorities, or any other cause beyond a Party's control. A Force Majeure event does not include acts of negligence or intentional wrongdoing by the Party claiming Force Majeure.

**Generating Facility** shall mean the Interconnection Customer's Electric Generating Unit(s) used for the production of electricity identified in the Interconnection Customer's Interconnection Request, but shall not include the Interconnection Customer's Interconnection Facilities.

**Generating Facility Capacity** shall mean the net capacity of the Generating Facility and the aggregate net capacity of the Generating Facility where it includes multiple energy production devices.

**Good Utility Practice** shall mean any of the practices, methods and acts engaged in or approved by a significant portion of the electric utility industry during the relevant time period, or any of the practices, methods and acts which, in the exercise of reasonable judgment in light of the facts known at the time the decision was made, could have been expected to accomplish the desired result at a reasonable cost consistent with good business practices, reliability, safety and expedition. Good Utility Practice is not intended to be any one of a number of the optimum practices, methods, or acts to the exclusion of all others, but rather to be acceptable practices, methods, or acts generally accepted in the region.

**Governmental Authority** shall mean any federal, state, local or other governmental, regulatory or administrative agency, court, commission, department, board, or other governmental subdivision, legislature, rulemaking board, tribunal, or other governmental authority having jurisdiction over the Parties, their respective facilities, or the respective services they provide, and exercising or entitled to exercise any administrative, executive, police, or taxing authority or power; provided, however, that such term does not include the Interconnection Customer, CAISO, Participating TO, or any Affiliate thereof.

**Hazardous Substances** shall mean any chemicals, materials or substances defined as or included in the definition of "hazardous substances," "hazardous wastes," "hazardous materials," "hazardous constituents," "restricted hazardous materials," "extremely hazardous substances," "toxic substances," "radioactive substances," "contaminants," "pollutants," "toxic pollutants" or words of similar meaning and regulatory effect under any applicable Environmental Law, or any other chemical, material or substance, exposure to which is prohibited, limited or regulated by any applicable Environmental Law.

**Initial Synchronization Date** shall mean the date upon which an Electric Generating Unit is initially synchronized and upon which Trial Operation begins.

**In-Service Date** shall mean the date upon which the Interconnection Customer reasonably expects it will be ready to begin use of the Participating TO's Interconnection Facilities to obtain back feed power.

**Interconnection Customer's Interconnection Facilities** shall mean all facilities and equipment, as identified in Appendix A of this LGIA, that are located between the Generating Facility and the Point of Change of Ownership, including any modification, addition, or upgrades to such facilities and equipment necessary to physically and electrically interconnect the Generating Facility to the Participating TO's Transmission System. Interconnection Customer's Interconnection Facilities are sole use facilities.

**Interconnection Facilities** shall mean the Participating TO's Interconnection Facilities and the Interconnection Customer's Interconnection Facilities. Collectively, Interconnection Facilities include all facilities and equipment between the Generating Facility and the Point of Interconnection, including any modification, additions or upgrades that are necessary to physically and electrically interconnect the Generating Facility to the Participating TO's Transmission System. Interconnection Facilities are sole use facilities and shall not include Distribution Upgrades, Stand Alone Network Upgrades or Network Upgrades.

**Interconnection Financial Security** shall have the meaning assigned to it in Section 1.2 of the LGIP.

**Interconnection Handbook** shall mean a handbook, developed by the Participating TO and posted on the Participating TO's web site or otherwise made available by the Participating TO, describing technical and operational requirements for wholesale generators and loads connected to the Participating TO's portion of the CAISO Controlled Grid, as such handbook may be modified or superseded from time to time. Participating TO's standards contained in the Interconnection Handbook shall be deemed consistent with Good Utility Practice and Applicable Reliability Standards. In the event of a conflict between the terms of this LGIA and the terms of the Participating TO's Interconnection Handbook, the terms in this LGIA shall apply.

**Interconnection Request** shall mean a request, in the form of Appendix 1 to the Large Generator Interconnection Procedures, in accordance with the CAISO Tariff.

**Interconnection Service** shall mean the service provided by the Participating TO and CAISO associated with interconnecting the Interconnection Customer's Generating Facility to the Participating TO's Transmission System and enabling the CAISO Controlled Grid to receive electric energy and capacity from the Generating Facility at the Point of Interconnection, pursuant to the terms of this LGIA, the Participating TO's Transmission Owner Tariff, and the CAISO Tariff.

**Interconnection Study** shall mean either of the following studies: the Phase I Interconnection Study or the Phase II Interconnection Study conducted or caused to be performed by the CAISO, in coordination with the applicable Participating TO(s), pursuant to the Large Generator Interconnection Procedures.

**IRS** shall mean the Internal Revenue Service.

**Large Generating Facility** shall mean a Generating Facility having a Generating Facility Capacity of more than 20 MW.

**Large Generator Interconnection Procedures (LGIP)** shall mean the CAISO protocol that sets forth the interconnection procedures applicable to an Interconnection Request pertaining to a Large Generating Facility that is included in CAISO Tariff Appendix Y.

**Large Generator Interconnection Study Process Agreement** shall mean the agreement between the Interconnection Customer and the CAISO for the conduct of the Interconnection Studies.

**Loss** shall mean any and all damages, losses, and claims, including claims and actions relating to injury to or death of any person or damage to property, demand, suits, recoveries, costs and expenses, court costs, attorney fees, and all other obligations by or to third parties.

**Material Modification** shall mean those modifications that have a material impact on the cost or timing of any Interconnection Request or any other valid interconnection request with a later queue priority date.

**Metering Equipment** shall mean all metering equipment installed or to be installed for measuring the output of the Generating Facility pursuant to this LGIA at the metering points, including but not limited to instrument transformers, MWh-meters, data acquisition equipment, transducers, remote terminal unit, communications equipment, phone lines, and fiber optics.

**NERC** shall mean the North American Electric Reliability Council or its successor organization.

**Network Upgrades** shall be Participating TO's Delivery Network Upgrades and Participating TO's Reliability Network Upgrades.

**Operational Control** shall mean the rights of the CAISO under the Transmission Control Agreement and the CAISO Tariff to direct the parties to the Transmission Control Agreement how to operate their transmission lines and facilities and other electric plant affecting the reliability of those lines and facilities for the purpose of affording comparable non-discriminatory transmission access and meeting applicable reliability criteria.

**Partial Termination** shall refer to termination of this LGIA as described in Article 2.4.4 where i) this LGIA shall be terminated under Article 2.4.4 only with respect to one or more Electric Generating Units of a Phased Generating Facility; ii) this LGIA shall continue to remain in force and effect with respect to the first Electric Generating Unit to be placed into service and any subsequent Electric Generating Units of the Phased



Generating Facility that are not the subject of the Partial Termination, and iii) no disconnection shall occur with respect to those phases of or Electric Generating Units within the Phased Generating Facility that are not terminated.

**Partial Termination Charge** shall mean that sum paid by the Interconnection Customer upon Partial Termination as provided for in Article 2.4.4.

**Partial Termination Charge Security** shall mean a form of security, issued in favor of the CAISO, naming the CAISO as the beneficiary for an amount equal to the maximum Partial Termination Charge that may become payable upon Partial Termination as provided for in Article 2.4.4. The Partial Termination Charge Security shall be in a form determined to be acceptable by the CAISO, of the type listed in CAISO Cluster LGIP (CAISO Tariff Appendix Y) Section 9.1 (a) – (f), but which security shall be held in favor of the CAISO. Partial Termination Charge Security is separate and distinct from the Interconnection Financial Security.

**Participating TO's Delivery Network Upgrades** shall mean the additions, modifications, and upgrades to the Participating TO's Transmission System at or beyond the Point of Interconnection, other than Reliability Network Upgrades, identified in the Interconnection Studies, as identified in Appendix A, to relieve constraints on the CAISO Controlled Grid.

**Participating TO's Interconnection Facilities** shall mean all facilities and equipment owned, controlled or operated by the Participating TO from the Point of Change of Ownership to the Point of Interconnection as identified in Appendix A to this LGIA, including any modifications, additions or upgrades to such facilities and equipment. Participating TO's Interconnection Facilities are sole use facilities and shall not include Distribution Upgrades, Stand Alone Network Upgrades or Network Upgrades.

**Participating TO's Reliability Network Upgrades** shall mean the additions, modifications, and upgrades to the Participating TO's Transmission System at or beyond the Point of Interconnection, identified in the Interconnection Studies, as identified in Appendix A, necessary to interconnect the Large Generating Facility safely and reliably to the Participating TO's Transmission System, which would not have been necessary but for the interconnection of the Large Generating Facility, including additions, modifications, and upgrades necessary to remedy short circuit or stability problems resulting from the interconnection of the Large Generating Facility to the Participating TO's Transmission System. Participating TO's Reliability Network Upgrades also include, consistent with Applicable Reliability Standards and Applicable Reliability Council practice, the Participating TO's facilities necessary to mitigate any adverse impact the Large Generating Facility's interconnection may have on a path's Applicable Reliability Council rating. Participating TO's Reliability Network Upgrades do not include any Participating TO's Delivery Network Upgrades.

**Participating TO's Transmission System** shall mean the facilities owned and operated by the Participating TO and that have been placed under the CAISO's Operational Control, which facilities form part of the CAISO Controlled Grid.

**Party or Parties** shall mean the Participating TO, CAISO, Interconnection Customer or the applicable combination of the above.

**Phase I Interconnection Study** shall mean the engineering study conducted or caused to be performed by the CAISO, in coordination with the applicable Participating TO(s), that evaluates the impact of the proposed interconnection on the safety and reliability of the Participating TO's Transmission System and, if applicable, an Affected System. The study shall identify and detail the system impacts that would result if the Generating Facility(ies) were interconnected without identified project modifications or system modifications, as provided in the On-Peak Deliverability Assessment (as defined in the CAISO Tariff), and other potential impacts, including but not limited to those identified in the Scoping Meeting as described in the Large Generator Interconnection Procedures. The study will also identify the approximate total costs, based on per unit costs, of mitigating these impacts, along with an equitable allocation of those costs to Interconnection Customers for their individual Generating Facilities.

**Phase II Interconnection Study** shall mean an engineering and operational study conducted or caused to be performed by the CAISO once per calendar year, in coordination with the applicable Participating TO(s), to determine the Point of Interconnection and a list of facilities (including the Participating TO's Interconnection Facilities, Network Upgrades, Distribution Upgrades, and Stand Alone Network Upgrades), the cost of those facilities, and the time required to interconnect the Generating Facility(ies) with the Participating TO's Transmission System.

**Phased Generating Facility** shall mean a Generating Facility that is structured to be completed and to achieve Commercial Operation in two or more successive phases that are specified in this LGIA, such that each phase comprises a portion of the total megawatt generation capacity of the entire Generating Facility.

**Point of Change of Ownership** shall mean the point, as set forth in Appendix A to this LGIA, where the Interconnection Customer's Interconnection Facilities connect to the Participating TO's Interconnection Facilities.

**Point of Interconnection** shall mean the point, as set forth in Appendix A to this LGIA, where the Interconnection Facilities connect to the Participating TO's Transmission System.

**QF PGA** shall mean a Qualifying Facility Participating Generator Agreement specifying the special provisions for the operating relationship between a Qualifying Facility and the CAISO, a pro forma version of which is set forth in Appendix B.3 of the CAISO Tariff.

**Qualifying Facility** shall mean a qualifying cogeneration facility or qualifying small power production facility, as defined in the Code of Federal Regulations, Title 18, Part 292 (18 C.F.R. §292).

**Reasonable Efforts** shall mean, with respect to an action required to be attempted or taken by a Party under this LGIA, efforts that are timely and consistent with Good Utility Practice and are otherwise substantially equivalent to those a Party would use to protect its own interests.

**Scoping Meeting** shall mean the meeting among representatives of the Interconnection Customer, the Participating TO(s), other Affected Systems, and the CAISO conducted for the purpose of discussing alternative interconnection options, to exchange information including any transmission data and earlier study evaluations that would be reasonably expected to impact such interconnection options, to analyze such information, and to determine the potential feasible Points of Interconnection.

**Stand Alone Network Upgrades** shall mean Network Upgrades that the Interconnection Customer may construct without affecting day-to-day operations of the CAISO Controlled Grid or Affected Systems during their construction. The Participating TO, the CAISO, and the Interconnection Customer must agree as to what constitutes Stand Alone Network Upgrades and identify them in Appendix A to this LGIA.

**System Protection Facilities** shall mean the equipment, including necessary protection signal communications equipment, that protects (1) the Participating TO's Transmission System, Participating TO's Interconnection Facilities, CAISO Controlled Grid, and Affected Systems from faults or other electrical disturbances occurring at the Generating Facility and (2) the Generating Facility from faults or other electrical system disturbances occurring on the CAISO Controlled Grid, Participating TO's Interconnection Facilities, and Affected Systems or on other delivery systems or other generating systems to which the CAISO Controlled Grid is directly connected.

**Transmission Control Agreement** shall mean CAISO FERC Electric Tariff No. 7.

**Trial Operation** shall mean the period during which the Interconnection Customer is engaged in on-site test operations and commissioning of an Electric Generating Unit prior to Commercial Operation.

**Transmission Revenue Balancing Account** shall have the meaning set forth in Appendix A of the CAISO Tariff.

## **ARTICLE 2. EFFECTIVE DATE, TERM AND TERMINATION**

**2.1 Effective Date.** This LGIA shall become effective upon execution by all Parties subject to acceptance by FERC (if applicable), or if filed unexecuted, upon the

date specified by FERC. The CAISO and Participating TO shall promptly file this LGIA with FERC upon execution in accordance with Article 3.1, if required.

**2.2 Term of Agreement.** Subject to the provisions of Article 2.3, this LGIA shall remain in effect for a period of ten (10) years from the Effective Date and shall be automatically renewed for each successive one-year period thereafter.

**2.3 Termination Procedures.**

2.3.1 **Written Notice.** This LGIA may be terminated by the Interconnection Customer after giving the CAISO and the Participating TO ninety (90) Calendar Days advance written notice, or by the CAISO and the Participating TO notifying FERC after the Generating Facility permanently ceases Commercial Operation.

2.3.2 **Default.** A Party may terminate this LGIA in accordance with Article 17.

2.3.3 **Suspension of Work.** This LGIA may be deemed terminated in accordance with Article 5.16.

2.3.4 **Notwithstanding Articles 2.3.1, 2.3.2, and 2.3.3, no termination shall become effective until the Parties have complied with all Applicable Laws and Regulations applicable to such termination, including the filing with FERC of a notice of termination of this LGIA (if applicable), which notice has been accepted for filing by FERC, and the Interconnection Customer has fulfilled its termination cost obligations under Article 2.4.**

2.3.5 **Partial Termination.** The Parties have included within this LGIA a provision for Partial Termination of this LGIA, the terms of which are set forth in Article 2.4.4. Notwithstanding any other term of this LGIA, Partial Termination shall be determined to have occurred in any and all circumstances where (i) one or more phases or Electric Generating Units for which the Interconnection Customer has secured Partial Termination eligibility are terminated, (ii) this LGIA has not been terminated in its entirety and (iii) all phases or Electric Generating Units have not been disconnected pursuant to Article 2.5.

**2.4 Termination Costs.** Immediately upon the other Parties' receipt of a notice of the termination of this LGIA pursuant to Article 2.3 above, the CAISO and the Participating TO will determine the total cost responsibility of the Interconnection Customer. If, as of the date of the other Parties' receipt of the notice of termination, the Interconnection Customer has not already paid its share of Network Upgrade costs, as set forth in Appendix G to this LGIA, the Participating TO will liquidate the Interconnection Customer's Interconnection Financial Security associated with its cost responsibility for Network Upgrades, in accordance with Section 9.4 of the LGIP.

The Interconnection Customer will also be responsible for all costs incurred or irrevocably committed to be incurred in association with the construction of the Participating TO's Interconnection Facilities (including any cancellation costs relating to orders or contracts for Interconnection Facilities and equipment) and other such expenses, including any Distribution Upgrades for which the Participating TO or CAISO has incurred expenses or has irrevocably committed to incur expenses and has not been reimbursed by the Interconnection Customer, as of the date of the other Parties' receipt of the notice of termination, subject to the limitations set forth in this Article 2.4. However, to the extent that the costs of the Participating TO's Network Upgrades have received Abandoned Plant Approval, the Interconnection Customer shall not be responsible for those charges. Nothing in this Article 2.4 shall limit the Parties' rights under Article 17. If, as of the date of the other Parties' receipt of the notice of termination, the Interconnection Customer has not already reimbursed the Participating TO and the CAISO for costs incurred to construct the Participating TO's Interconnection Facilities, the Participating TO will liquidate the Interconnection Customer's Interconnection Financial Security associated with the construction of the Participating TO's Interconnection Facilities, in accordance with Section 9.4 of the LGIP. If the amount of the Interconnection Financial Security liquidated by the Participating TO under this Article 2.4 is insufficient to compensate the CAISO and the Participating TO for actual costs associated with the construction of the Participating TO's Interconnection Facilities contemplated in this Article, any additional amounts will be the responsibility of the Interconnection Customer, subject to the provisions of Section 9.4 of the LGIP. Any such additional amounts due from the Interconnection Customer beyond the amounts covered by its Interconnection Financial Security will be due to the Participating TO immediately upon termination of this LGIA in accordance with Section 9.4 of the LGIP.

If the amount of the Interconnection Financial Security exceeds the Interconnection Customer's cost responsibility under Section 9.4 of the LGIP, any excess amount will be released to the Interconnection Customer in accordance with Section 9.4 of the LGIP.

(a) *Interrelationship of Abandoned Plant Approval and Termination Costs.* If the Participating TO is granted Abandoned Plant Approval, then the Interconnection Customer shall not be responsible for any termination costs for the Network Upgrades that SCE will upfront finance. The Parties acknowledge and agree that the Partial Termination Charge does not apply in situations of termination of this LGIA in its entirety, and no reduction of the Partial Termination Charge shall be made by reason of Abandoned Plant Approval.

(b) *Interrelationship of Termination of the Entire LGIA under Article 2.4 and Partial Termination under 2.4.4.* Nothing in this Article 2.4 shall limit the operation of those provisions pertaining to Partial Termination or the Partial Termination Charge contained in Article 2.4.4. In the event of

Partial Termination, the provisions of Article 2.4.4 shall govern.

If the amount of the Interconnection Financial Security exceeds the Interconnection Customer's cost responsibility under Section 9.4 of the LGIP, any excess amount will be released to the Interconnection Customer in accordance with Section 9.4 of the LGIP.

- 2.4.1 Notwithstanding the foregoing, in the event of termination by a Party, all Parties shall use commercially Reasonable Efforts to mitigate the costs, damages and charges arising as a consequence of termination. With respect to any portion of the Participating TO's Interconnection Facilities that have not yet been constructed or installed, the Participating TO shall to the extent possible and with the Interconnection Customer's authorization cancel any pending orders of, or return, any materials or equipment for, or contracts for construction of, such facilities; provided that in the event the Interconnection Customer elects not to authorize such cancellation, the Interconnection Customer shall assume all payment obligations with respect to such materials, equipment, and contracts, and the Participating TO shall deliver such material and equipment, and, if necessary, assign such contracts, to the Interconnection Customer as soon as practicable, at the Interconnection Customer's expense. To the extent that the Interconnection Customer has already paid the Participating TO for any or all such costs of materials or equipment not taken by the Interconnection Customer, the Participating TO shall promptly refund such amounts to the Interconnection Customer, less any costs, including penalties, incurred by the Participating TO to cancel any pending orders of or return such materials, equipment, or contracts.
- 2.4.2 The Participating TO may, at its option, retain any portion of such materials, equipment, or facilities that the Interconnection Customer chooses not to accept delivery of, in which case the Participating TO shall be responsible for all costs associated with procuring such materials, equipment, or facilities.
- 2.4.3 With respect to any portion of the Interconnection Facilities, and any other facilities already installed or constructed pursuant to the terms of this LGIA, Interconnection Customer shall be responsible for all costs associated with the removal, relocation or other disposition or retirement of such materials, equipment, or facilities.
- 2.4.4 **Partial Termination.** The Parties agree that this LGIA shall provide for Partial Termination on the terms and conditions of this Article 2.4.4. This Article 2.4.4 shall apply only in the event of Partial Termination and shall not apply if this LGIA is terminated with respect to the entire Generating Facility. Partial Termination shall be deemed to have occurred, and the terms of this Article 2.4.4 shall apply in any and all situations of

termination under this LGIA where the LGIA is not terminated in its entirety with the corresponding disconnection of all Electric Generating Units or phases of the Generating Facility that are the subject of this LGIA; provided, however, that Partial Termination may occur only with respect to those Electric Generating Units for which the Interconnection Customer has previously provided Partial Termination Charge Security, such that no Partial Termination of an Electric Generating Unit may occur for which the Partial Termination right has not been secured.

**2.4.4.1** Except as set forth in Appendix A, Section 14, Table 2B, in the event of Partial Termination, the Interconnection Customer shall pay a Partial Termination Charge. The Partial Termination Charge shall be payable to the CAISO and shall be secured by the Partial Termination Charge Security. The amount of the Partial Termination Charge shall be an amount equal to the product of ten percent (10%) of the dollar amount of the Interconnection Customer's cost responsibility for the Network Upgrades in the absence of Participating TO upfront funding for the entire Phased Generating Facility times (multiplied by) the ratio of the megawatt capacity of the portion of the Phased Generating Facility that is terminated to the megawatt capacity of the entire Phased Generating Facility. The following specific items related to Partial Termination are set forth in Appendix A, Section 12: the amount of the Partial Termination Charge and Partial Termination Charge Security; the timing for posting of the security, and the details for reduction of the security for Electric Generating Units that achieve Commercial Operation prior to Partial Termination.

**2.4.4.2** Partial Termination may be exercised following the delivery of the Partial Termination Charge Security for the Electric Generating Units for which the Interconnection Customer has elected to make the Partial Termination available either: (i) at the option of the Interconnection Customer, exercisable in its sole discretion; or, (ii) at the mutual discretion of the Participating TO's and the CAISO, upon the failure of the Interconnection Customer to meet any of the milestones set forth in Appendix A, subject to the terms and conditions of Appendix A, Section 14(d)(ii). The notice referenced in this Article may run concurrently with any other notice provided by the Party under this LGIA (including notices pertaining to Default, or failure to meet milestones relating to decision points) and shall not provide the noticed Parties with any additional period of time for cure in such other notices.

**2.4.4.3** Upon written notice by either (i) the Interconnection Customer to the other Parties; or (ii) the Participating TO and the

CAISO to the Interconnection Customer; that the noticing Party has invoked Partial Termination, the Partial Termination Charge shall become immediately due and owing, and the CAISO shall liquidate the Partial Termination Charge Security for collection of the applicable Partial Termination Charge, and apply the Partial Termination funds as specified in Section 2.4.4.5.

**2.4.4.4** Upon Partial Termination, the Parties shall amend this LGIA to remove from this LGIA the terms and conditions specifying continuing rights and obligations of the Parties with respect to the applicable Electric Generating Unit(s) of the Phased Generating Facility which have been the subject of the Partial Termination, and to specify the continuing rights and obligations of the Parties with respect to the Electric Generating Units which remain the subject of the LGIA. The amended LGIA shall reflect that the Parties have partially terminated the LGIA as to the terminated Electric Generating Unit(s), but not as to any provisions relevant to the Electric Generating Unit(s) for which Partial Termination has not been exercised. The amended LGIA shall further reflect the lower generation capacity of the Generating Facility in its new condition following Partial Termination, and, to the extent that the interconnection configuration that has been modified as a result of the Partial Termination, shall set forth the modified configuration in the amended and restated Appendices to this LGIA.

**2.4.4.5** After written notice of Partial Termination under Article 2.4.4.5, and the expiration of any opportunity to cure relating to any concurrent notices (such as notices of Default or notices relating to milestones and decision points) the CAISO shall cause the Partial Termination Charge funds to be applied and disbursed in such a manner as to cause a credit toward the Transmission Revenue Balancing Account ("TRBA") of the Participating TO. The Parties agree to cooperate and execute such agreements and undertake such actions as may be necessary to apply the funds to credit this account.

**2.4.4.6** If this LGIA is terminated in its entirety prior to any event of Partial Termination, then any Partial Termination Charge Security which was provided to the CAISO prior to the Partial Termination shall be returned to the Interconnection Customer. The Parties acknowledge that there could be a situation where the LGIA was partially terminated in one transaction, followed by a termination of the entire LGIA in a subsequent transaction, in that event, the amount of Partial Termination Charge Security associated with such previous Partial Termination shall not be returned to the Interconnection Customer.



**2.4.4.7** In the event of Partial Termination, the Partial Termination Charge and application of such charge as a credit to the Participating TO's TRBA shall serve as the recourse of the CAISO and the Participating TO for any costs associated with the Network Upgrades that are the subject of upfront financing by the Participating TO as described in this LGIA, and the Interconnection Customer shall not be responsible for payment to the CAISO or the Participating TO for any further costs, charges or expenses attributable to the Network Upgrades that the Participating TO is obligated to finance as described in this LGIA by virtue of its commitment to provide upfront financing.

**2.5 Disconnection.** Upon termination of this LGIA, the Parties will take all appropriate steps to disconnect the Large Generating Facility from the Participating TO's Transmission System. All costs required to effectuate such disconnection shall be borne by the terminating Party, unless such termination resulted from the non-terminating Party's Default of this LGIA or such non-terminating Party otherwise is responsible for these costs under this LGIA.

**2.6 Survival.** This LGIA shall continue in effect after termination to the extent necessary to provide for final billings and payments and for costs incurred hereunder, including billings and payments pursuant to this LGIA; to permit the determination and enforcement of liability and indemnification obligations arising from acts or events that occurred while this LGIA was in effect; and to permit each Party to have access to the lands of the other Parties pursuant to this LGIA or other applicable agreements, to disconnect, remove or salvage its own facilities and equipment.

### **ARTICLE 3. REGULATORY FILINGS AND CAISO TARIFF COMPLIANCE**

**3.1 Filing.** The Participating TO and the CAISO shall file this LGIA (and any amendment hereto) with the appropriate Governmental Authority(ies), if required. The Interconnection Customer may request that any information so provided be subject to the confidentiality provisions of Article 22. If the Interconnection Customer has executed this LGIA, or any amendment thereto, the Interconnection Customer shall reasonably cooperate with the Participating TO and CAISO with respect to such filing and to provide any information reasonably requested by the Participating TO or CAISO needed to comply with applicable regulatory requirements.

**3.2 Agreement Subject to CAISO Tariff.** The Interconnection Customer will comply with all applicable provisions of the CAISO Tariff, including the LGIP.

**3.3 Relationship Between this LGIA and the CAISO Tariff.** With regard to rights and obligations between the Participating TO and the Interconnection Customer,

if and to the extent a matter is specifically addressed by a provision of this LGIA (including any appendices, schedules or other attachments to this LGIA), the provisions of this LGIA shall govern. If and to the extent a provision of this LGIA is inconsistent with the CAISO Tariff and dictates rights and obligations between the CAISO and the Participating TO or the CAISO and the Interconnection Customer, the CAISO Tariff shall govern.

- 3.4 Relationship Between this LGIA and the QF PGA.** With regard to the rights and obligations of a Qualifying Facility that has entered into a QF PGA with the CAISO and has entered into this LGIA, if and to the extent a matter is specifically addressed by a provision of the QF PGA that is inconsistent with this LGIA, the terms of the QF PGA shall govern.

#### **ARTICLE 4. SCOPE OF SERVICE**

- 4.1 Interconnection Service.** Interconnection Service allows the Interconnection Customer to connect the Large Generating Facility to the Participating TO's Transmission System and be eligible to deliver the Large Generating Facility's output using the available capacity of the CAISO Controlled Grid. To the extent the Interconnection Customer wants to receive Interconnection Service, the Participating TO shall construct facilities identified in Appendices A and C that the Participating TO is responsible to construct.

Interconnection Service does not necessarily provide the Interconnection Customer with the capability to physically deliver the output of its Large Generating Facility to any particular load on the CAISO Controlled Grid without incurring congestion costs. In the event of transmission constraints on the CAISO Controlled Grid, the Interconnection Customer's Large Generating Facility shall be subject to the applicable congestion management procedures in the CAISO Tariff in the same manner as all other resources.

- 4.2 Provision of Service.** The Participating TO and the CAISO shall provide Interconnection Service for the Large Generating Facility.
- 4.3 Performance Standards.** Each Party shall perform all of its obligations under this LGIA in accordance with Applicable Laws and Regulations, Applicable Reliability Standards, and Good Utility Practice, and to the extent a Party is required or prevented or limited in taking any action by such regulations and standards, such Party shall not be deemed to be in Breach of this LGIA for its compliance therewith. If such Party is the CAISO or Participating TO, then that Party shall amend the LGIA and submit the amendment to FERC for approval.
- 4.4 No Transmission Service.** The execution of this LGIA does not constitute a request for, nor the provision of, any transmission service under the CAISO Tariff, and does not convey any right to deliver electricity to any specific customer or point of delivery.

**4.5 Interconnection Customer Provided Services.** The services provided by Interconnection Customer under this LGIA are set forth in Article 9.6 and Article 13.5.1. Interconnection Customer shall be paid for such services in accordance with Article 11.6.

## **ARTICLE 5. INTERCONNECTION FACILITIES ENGINEERING, PROCUREMENT, AND CONSTRUCTION**

Interconnection Facilities, Network Upgrades, and Distribution Upgrades shall be studied, designed, and constructed pursuant to Good Utility Practice. Such studies, design and construction shall be based on the assumed accuracy and completeness of all technical information received by the Participating TO and the CAISO from the Interconnection Customer associated with interconnecting the Large Generating Facility.

**5.1 Options.** Unless otherwise mutually agreed among the Parties, the Interconnection Customer shall select the In-Service Date, Initial Synchronization Date, and Commercial Operation Date; and either Standard Option or Alternate Option set forth below for completion of the Participating TO's Interconnection Facilities and Network Upgrades as set forth in Appendix A, Interconnection Facilities, Network Upgrades, and Distribution Upgrades, and such dates and selected option shall be set forth in Appendix B, Milestones.

**5.1.1 Standard Option.** The Participating TO shall design, procure, and construct the Participating TO's Interconnection Facilities, Network Upgrades, and Distribution Upgrades, using Reasonable Efforts to complete the Participating TO's Interconnection Facilities, Network Upgrades, and Distribution Upgrades by the dates set forth in Appendix B, Milestones. The Participating TO shall not be required to undertake any action which is inconsistent with its standard safety practices, its material and equipment specifications, its design criteria and construction procedures, its labor agreements, and Applicable Laws and Regulations. In the event the Participating TO reasonably expects that it will not be able to complete the Participating TO's Interconnection Facilities, Network Upgrades, and Distribution Upgrades by the specified dates, the Participating TO shall promptly provide written notice to the Interconnection Customer and the CAISO and shall undertake Reasonable Efforts to meet the earliest dates thereafter.

**5.1.2 Alternate Option.** If the dates designated by the Interconnection Customer are acceptable to the Participating TO, the Participating TO shall so notify the Interconnection Customer within thirty (30) Calendar Days, and shall assume responsibility for the design, procurement and construction of the Participating TO's Interconnection Facilities by the designated dates.

If the Participating TO subsequently fails to complete the Participating TO's Interconnection Facilities by the In-Service Date, to the extent necessary to provide back feed power; or fails to complete Network Upgrades by the Initial Synchronization Date to the extent necessary to allow for Trial Operation at full power output, unless other arrangements are made by the Parties for such Trial Operation; or fails to complete the Network Upgrades by the Commercial Operation Date, as such dates are reflected in Appendix B, Milestones; the Participating TO shall pay the Interconnection Customer liquidated damages in accordance with Article 5.3, Liquidated Damages, provided, however, the dates designated by the Interconnection Customer shall be extended day for day for each day that the CAISO refuses to grant clearances to install equipment.

**5.1.3 Option to Build.** If the dates designated by the Interconnection Customer are not acceptable to the Participating TO, the Participating TO shall so notify the Interconnection Customer within thirty (30) Calendar Days, and unless the Parties agree otherwise, the Interconnection Customer shall have the option to assume responsibility for the design, procurement and construction of the Participating TO's Interconnection Facilities and Stand Alone Network Upgrades. If the Interconnection Customer elects to exercise its option to assume responsibility for the design, procurement and construction of the Participating TO's Interconnection Facilities and Stand Alone Network Upgrades, it shall so notify the Participating TO within thirty (30) Calendar Days of receipt of the Participating TO's notification that the designated dates are not acceptable to the Participating TO. The Participating TO, CAISO, and Interconnection Customer must agree as to what constitutes Stand Alone Network Upgrades and identify such Stand Alone Network Upgrades in Appendix A to this LGIA. Except for Stand Alone Network Upgrades, the Interconnection Customer shall have no right to construct Network Upgrades under this option.

**5.1.4 Negotiated Option.** If the Interconnection Customer elects not to exercise its option under Article 5.1.3, Option to Build, the Interconnection Customer shall so notify the Participating TO within thirty (30) Calendar Days of receipt of the Participating TO's notification that the designated dates are not acceptable to the Participating TO, and the Parties shall in good faith attempt to negotiate terms and conditions (including revision of the specified dates and liquidated damages, the provision of incentives or the procurement and construction of a portion of the Participating TO's Interconnection Facilities and Stand Alone Network Upgrades by the Interconnection Customer) pursuant to which the Participating TO is responsible for the design, procurement and construction of the Participating TO's Interconnection Facilities and Network Upgrades. If the Parties are unable to reach agreement on such terms and conditions, the

Participating TO shall assume responsibility for the design, procurement and construction of the Participating TO's Interconnection Facilities and Network Upgrades pursuant to Article 5.1.1, Standard Option.

**5.2 General Conditions Applicable to Option to Build.** If the Interconnection Customer assumes responsibility for the design, procurement and construction of the Participating TO's Interconnection Facilities and Stand Alone Network Upgrades,

(1) the Interconnection Customer shall engineer, procure equipment, and construct the Participating TO's Interconnection Facilities and Stand Alone Network Upgrades (or portions thereof) using Good Utility Practice and using standards and specifications provided in advance by the Participating TO;

(2) The Interconnection Customer's engineering, procurement and construction of the Participating TO's Interconnection Facilities and Stand Alone Network Upgrades shall comply with all requirements of law to which the Participating TO would be subject in the engineering, procurement or construction of the Participating TO's Interconnection Facilities and Stand Alone Network Upgrades;

(3) the Participating TO shall review, and the Interconnection Customer shall obtain the Participating TO's approval of, the engineering design, equipment acceptance tests, and the construction of the Participating TO's Interconnection Facilities and Stand Alone Network Upgrades, which approval shall not be unreasonably withheld, and the CAISO may, at its option, review the engineering design, equipment acceptance tests, and the construction of the Participating TO's Interconnection Facilities and Stand Alone Network Upgrades;

(4) prior to commencement of construction, the Interconnection Customer shall provide to the Participating TO, with a copy to the CAISO for informational purposes, a schedule for construction of the Participating TO's Interconnection Facilities and Stand Alone Network Upgrades, and shall promptly respond to requests for information from the Participating TO;

(5) at any time during construction, the Participating TO shall have the right to gain unrestricted access to the Participating TO's Interconnection Facilities and Stand Alone Network Upgrades and to conduct inspections of the same;

(6) at any time during construction, should any phase of the engineering, equipment procurement, or construction of the Participating TO's Interconnection Facilities and Stand Alone Network Upgrades not meet

the standards and specifications provided by the Participating TO, the Interconnection Customer shall be obligated to remedy deficiencies in that portion of the Participating TO's Interconnection Facilities and Stand Alone Network Upgrades;

(7) the Interconnection Customer shall indemnify the CAISO and Participating TO for claims arising from the Interconnection Customer's construction of the Participating TO's Interconnection Facilities and Stand Alone Network Upgrades under the terms and procedures applicable to Article 18.1 Indemnity;

(8) The Interconnection Customer shall transfer control of the Participating TO's Interconnection Facilities to the Participating TO and shall transfer Operational Control of Stand Alone Network Upgrades to the CAISO;

(9) Unless the Parties otherwise agree, the Interconnection Customer shall transfer ownership of the Participating TO's Interconnection Facilities and Stand Alone Network Upgrades to the Participating TO. As soon as reasonably practicable, but within twelve months after completion of the construction of the Participating TO's Interconnection Facilities and Stand Alone Network Upgrades, the Interconnection Customer shall provide an invoice of the final cost of the construction of the Participating TO's Interconnection Facilities and Stand Alone Network Upgrades to the Participating TO, which invoice shall set forth such costs in sufficient detail to enable the Participating TO to reflect the proper costs of such facilities in its transmission rate base and to identify the investment upon which refunds will be provided;

(10) the Participating TO shall accept for operation and maintenance the Participating TO's Interconnection Facilities and Stand Alone Network Upgrades to the extent engineered, procured, and constructed in accordance with this Article 5.2; and

(11) The Interconnection Customer's engineering, procurement and construction of the Participating TO's Interconnection Facilities and Stand Alone Network Upgrades shall comply with all requirements of the "Option to Build" conditions set forth in Appendix C. Interconnection Customer shall deliver to the Participating TO "as-built" drawings, information, and any other documents that are reasonably required by the Participating TO to assure that the Interconnection Facilities and Stand-Alone Network Upgrades are built to the standards and specifications required by the Participating TO.

**5.3 Liquidated Damages.** The actual damages to the Interconnection Customer, in the event the Participating TO's Interconnection Facilities or Network Upgrades are not completed by the dates designated by the Interconnection Customer and

accepted by the Participating TO pursuant to subparagraphs 5.1.2 or 5.1.4, above, may include Interconnection Customer's fixed operation and maintenance costs and lost opportunity costs. Such actual damages are uncertain and impossible to determine at this time. Because of such uncertainty, any liquidated damages paid by the Participating TO to the Interconnection Customer in the event that the Participating TO does not complete any portion of the Participating TO's Interconnection Facilities or Network Upgrades by the applicable dates, shall be an amount equal to  $\frac{1}{2}$  of 1 percent per day of the actual cost of the Participating TO's Interconnection Facilities and Network Upgrades, in the aggregate, for which the Participating TO has assumed responsibility to design, procure and construct.

However, in no event shall the total liquidated damages exceed 20 percent of the actual cost of the Participating TO's Interconnection Facilities and Network Upgrades for which the Participating TO has assumed responsibility to design, procure, and construct. The foregoing payments will be made by the Participating TO to the Interconnection Customer as just compensation for the damages caused to the Interconnection Customer, which actual damages are uncertain and impossible to determine at this time, and as reasonable liquidated damages, but not as a penalty or a method to secure performance of this LGIA. Liquidated damages, when the Parties agree to them, are the exclusive remedy for the Participating TO's failure to meet its schedule.

No liquidated damages shall be paid to the Interconnection Customer if: (1) the Interconnection Customer is not ready to commence use of the Participating TO's Interconnection Facilities or Network Upgrades to take the delivery of power for the Electric Generating Unit's Trial Operation or to export power from the Electric Generating Unit on the specified dates, unless the Interconnection Customer would have been able to commence use of the Participating TO's Interconnection Facilities or Network Upgrades to take the delivery of power for Electric Generating Unit's Trial Operation or to export power from the Electric Generating Unit, but for the Participating TO's delay; (2) the Participating TO's failure to meet the specified dates is the result of the action or inaction of the Interconnection Customer or any other interconnection customer who has entered into an interconnection agreement with the CAISO and/or Participating TO, action or inaction by the CAISO, or any cause beyond the Participating TO's reasonable control or reasonable ability to cure; (3) the Interconnection Customer has assumed responsibility for the design, procurement and construction of the Participating TO's Interconnection Facilities and Stand Alone Network Upgrades; or (4) the Parties have otherwise agreed.

In no event shall the CAISO have any responsibility or liability to the Interconnection Customer for liquidated damages pursuant to the provisions of this Article 5.3.

**5.4 Power System Stabilizers.** The Interconnection Customer shall procure, install, maintain and operate Power System Stabilizers in accordance with Applicable Reliability Standards, the guidelines and procedures established by the Applicable Reliability Council, and the provisions of Section 4.6.5.1 of the CAISO Tariff. The CAISO reserves the right to establish reasonable minimum acceptable settings for any installed Power System Stabilizers, subject to the design and operating limitations of the Large Generating Facility. If the Large Generating Facility's Power System Stabilizers are removed from service or not capable of automatic operation, the Interconnection Customer shall immediately notify the CAISO and the Participating TO and restore the Power System Stabilizers to operation as soon as possible. The CAISO shall have the right to order the reduction in output or disconnection of the Large Generating Facility if the reliability of the CAISO Controlled Grid would be adversely affected as a result of improperly tuned Power System Stabilizers. The requirements of this Article 5.4 shall apply to Asynchronous Generating Facilities in accordance with Appendix H.

**5.5 Equipment Procurement.** If responsibility for construction of the Participating TO's Interconnection Facilities or Network Upgrades is to be borne by the Participating TO, then the Participating TO shall commence design of the Participating TO's Interconnection Facilities or Network Upgrades and procure necessary equipment as soon as practicable after all of the following conditions are satisfied, unless the Parties otherwise agree in writing:

5.5.1 The CAISO, in coordination with the applicable Participating TO(s), has completed the Phase II Interconnection Study pursuant to the Large Generator Interconnection Facilities Study Process Agreement;

5.5.2 The Participating TO has received written authorization to proceed with design and procurement from the Interconnection Customer by the date specified in Appendix B, Milestones; and

5.5.3 The Interconnection Customer has provided security to the Participating TO in accordance with Article 11.5 by the dates specified in Appendix B, Milestones.

**5.6 Construction Commencement.** The Participating TO shall commence construction of the Participating TO's Interconnection Facilities and Network Upgrades for which it is responsible as soon as practicable after the following additional conditions are satisfied:

5.6.1 Approval of the appropriate Governmental Authority has been obtained for any facilities requiring regulatory approval;



- 5.6.2 Necessary real property rights and rights-of-way have been obtained, to the extent required for the construction of a discrete aspect of the Participating TO's Interconnection Facilities, and Network Upgrades;
- 5.6.3 The Participating TO has received written authorization to proceed with construction from the Interconnection Customer by the date specified in Appendix B, Milestones; and
- 5.6.4 The Interconnection Customer has provided payment and security to the Participating TO in accordance with Article 11.5 by the dates specified in Appendix B, Milestones.
- 5.7 Work Progress.** The Parties will keep each other advised periodically as to the progress of their respective design, procurement and construction efforts. Any Party may, at any time, request a progress report from another Party. If, at any time, the Interconnection Customer determines that the completion of the Participating TO's Interconnection Facilities will not be required until after the specified In-Service Date, the Interconnection Customer will provide written notice to the Participating TO and CAISO of such later date upon which the completion of the Participating TO's Interconnection Facilities will be required.
- 5.8 Information Exchange.** As soon as reasonably practicable after the Effective Date, the Parties shall exchange information regarding the design and compatibility of the Interconnection Customer's Interconnection Facilities and Participating TO's Interconnection Facilities and compatibility of the Interconnection Facilities with the Participating TO's Transmission System, and shall work diligently and in good faith to make any necessary design changes.
- 5.9 Limited Operation.** If any of the Participating TO's Interconnection Facilities or Network Upgrades are not reasonably expected to be completed prior to the Commercial Operation Date of the Electric Generating Unit, the Participating TO and/or CAISO, as applicable, shall, upon the request and at the expense of the Interconnection Customer, perform operating studies on a timely basis to determine the extent to which the Electric Generating Unit and the Interconnection Customer's Interconnection Facilities may operate prior to the completion of the Participating TO's Interconnection Facilities or Network Upgrades consistent with Applicable Laws and Regulations, Applicable Reliability Standards, Good Utility Practice, and this LGIA. The Participating TO and CAISO shall permit Interconnection Customer to operate the Electric Generating Unit and the Interconnection Customer's Interconnection Facilities in accordance with the results of such studies.
- 5.10 Interconnection Customer's Interconnection Facilities.** The Interconnection Customer shall, at its expense, design, procure, construct, own and install the Interconnection Customer's Interconnection Facilities, as set forth in Appendix A.

- 5.10.1 Large Generating Facility and Interconnection Customer's Interconnection Facilities Specifications. In addition to the Interconnection Customer's responsibility to submit technical data with its Interconnection Request as required by Section 3.5.1 of the LGIP, the Interconnection Customer shall submit all remaining necessary specifications for the Interconnection Customer's Interconnection Facilities and Large Generating Facility, including System Protection Facilities, to the Participating TO and the CAISO at least one hundred eighty (180) Calendar Days prior to the Initial Synchronization Date; and final specifications for review and comment at least ninety (90) Calendar Days prior to the Initial Synchronization Date. The Participating TO and the CAISO shall review such specifications pursuant to this LGIA and the LGIP to ensure that the Interconnection Customer's Interconnection Facilities and Large Generating Facility are compatible with the technical specifications, operational control, safety requirements, and any other applicable requirements of the Participating TO and the CAISO and comment on such specifications within thirty (30) Calendar Days of the Interconnection Customer's submission. All specifications provided hereunder shall be deemed confidential.
- 5.10.2 Participating TO's and CAISO's Review. The Participating TO's and the CAISO's review of the Interconnection Customer's final specifications shall not be construed as confirming, endorsing, or providing a warranty as to the design, fitness, safety, durability or reliability of the Large Generating Facility, or the Interconnection Customer's Interconnection Facilities. Interconnection Customer shall make such changes to the Interconnection Customer's Interconnection Facilities as may reasonably be required by the Participating TO or the CAISO, in accordance with Good Utility Practice, to ensure that the Interconnection Customer's Interconnection Facilities are compatible with the technical specifications, Operational Control, and safety requirements of the Participating TO or the CAISO.
- 5.10.3 Interconnection Customer's Interconnection Facilities Construction. The Interconnection Customer's Interconnection Facilities shall be designed and constructed in accordance with Good Utility Practice. Within one hundred twenty (120) Calendar Days after the Commercial Operation Date, unless the Participating TO and Interconnection Customer agree on another mutually acceptable deadline, the Interconnection Customer shall deliver to the Participating TO and CAISO "as-built" drawings, information and documents for the Interconnection Customer's Interconnection Facilities and the Electric Generating Unit(s), such as: a one-line diagram, a site plan showing the Large Generating Facility and the Interconnection Customer's Interconnection Facilities, plan and elevation drawings showing the layout of the Interconnection Customer's Interconnection Facilities, a relay functional diagram, relaying AC and DC schematic wiring diagrams and relay settings for all facilities associated with the Interconnection Customer's step-up transformers, the facilities connecting

the Large Generating Facility to the step-up transformers and the Interconnection Customer's Interconnection Facilities, and the impedances (determined by factory tests) for the associated step-up transformers and the Electric Generating Units. The Interconnection Customer shall provide the Participating TO and the CAISO specifications for the excitation system, automatic voltage regulator, Large Generating Facility control and protection settings, transformer tap settings, and communications, if applicable. Any deviations from the relay settings, machine specifications, and other specifications originally submitted by the Interconnection Customer shall be assessed by the Participating TO and the CAISO pursuant to the appropriate provisions of this LGIA and the LGIP.

5.10.4 Interconnection Customer to Meet Requirements of the Participating TO's Interconnection Handbook. The Interconnection Customer shall comply with the Participating TO's Interconnection Handbook.

**5.11 Participating TO's Interconnection Facilities Construction.** The Participating TO's Interconnection Facilities shall be designed and constructed in accordance with Good Utility Practice. Upon request, within one hundred twenty (120) Calendar Days after the Commercial Operation Date, unless the Participating TO and Interconnection Customer agree on another mutually acceptable deadline, the Participating TO shall deliver to the Interconnection Customer and the CAISO the following "as-built" drawings, information and documents for the Participating TO's Interconnection Facilities. No as-built drawings will be provided.

The Participating TO will obtain control for operating and maintenance purposes of the Participating TO's Interconnection Facilities and Stand Alone Network Upgrades upon completion of such facilities. Pursuant to Article 5.2, the CAISO will obtain Operational Control of the Stand Alone Network Upgrades prior to the Commercial Operation Date.

**5.12 Access Rights.** Upon reasonable notice and supervision by a Party, and subject to any required or necessary regulatory approvals, a Party ("Granting Party") shall furnish at no cost to the other Party ("Access Party") any rights of use, licenses, rights of way and easements with respect to lands owned or controlled by the Granting Party, its agents (if allowed under the applicable agency agreement), or any Affiliate, that are necessary to enable the Access Party to obtain ingress and egress to construct, operate, maintain, repair, test (or witness testing), inspect, replace or remove facilities and equipment to: (i) interconnect the Large Generating Facility with the Participating TO's Transmission System; (ii) operate and maintain the Large Generating Facility, the Interconnection Facilities and the Participating TO's Transmission System; and (iii) disconnect or remove the Access Party's facilities and equipment upon termination of this LGIA. In exercising such licenses, rights of way and easements, the Access Party shall not unreasonably disrupt or interfere with

normal operation of the Granting Party's business and shall adhere to the safety rules and procedures established in advance, as may be changed from time to time, by the Granting Party and provided to the Access Party.

- 5.13 Lands of Other Property Owners.** If any part of the Participating TO's Interconnection Facilities and/or Network Upgrades are to be installed on property owned by persons other than the Interconnection Customer or Participating TO, the Participating TO shall at the Interconnection Customer's expense use efforts, similar in nature and extent to those that it typically undertakes on its own behalf or on behalf of its Affiliates, including use of its eminent domain authority, and to the extent consistent with state law, to procure from such persons any rights of use, licenses, rights of way and easements that are necessary to construct, operate, maintain, test, inspect, replace or remove the Participating TO's Interconnection Facilities and/or Network Upgrades upon such property.
- 5.14 Permits.** Participating TO and Interconnection Customer shall cooperate with each other in good faith in obtaining all permits, licenses and authorization that are necessary to accomplish the interconnection in compliance with Applicable Laws and Regulations. With respect to this paragraph, the Participating TO shall provide permitting assistance to the Interconnection Customer comparable to that provided to the Participating TO's own, or an Affiliate's generation.
- 5.15 Early Construction of Base Case Facilities.** The Interconnection Customer may request the Participating TO to construct, and the Participating TO shall construct, using Reasonable Efforts to accommodate Interconnection Customer's In-Service Date, all or any portion of any Network Upgrades required for Interconnection Customer to be interconnected to the Participating TO's Transmission System which are included in the Base Case of the Interconnection Studies for the Interconnection Customer, and which also are required to be constructed for another interconnection customer, but where such construction is not scheduled to be completed in time to achieve Interconnection Customer's In-Service Date.
- 5.16 Suspension.** The Interconnection Customer's Interconnection Request was included in the Generator Downsizing Study conducted pursuant to CAISO Tariff Appendix GG, wherein the Interconnection Customer was a Downsizing Generator with a Generator Downsizing Request (as such terms are defined in CAISO Tariff Appendix GG) to reduce the megawatt capacity of the Generating Facility. Accordingly, notwithstanding any other provision of the LGIA or this Article 5.16, the Interconnection Customer shall have no further right of suspension.

The Interconnection Customer reserves the right, upon written notice to the Participating TO and the CAISO, to suspend at any time all work associated with the construction and installation of the Participating TO's Interconnection Facilities, Network Upgrades, and/or Distribution Upgrades required under this

LGIA, other than Network Upgrades identified in the Phase II Interconnection Study as common to multiple Generating Facilities, with the condition that the Participating TO's electrical system and the CAISO Controlled Grid shall be left in a safe and reliable condition in accordance with Good Utility Practice and the Participating TO's safety and reliability criteria and the CAISO's Applicable Reliability Standards. In such event, the Interconnection Customer shall be responsible for all reasonable and necessary costs which the Participating TO (i) has incurred pursuant to this LGIA prior to the suspension and (ii) incurs in suspending such work, including any costs incurred to perform such work as may be necessary to ensure the safety of persons and property and the integrity of the Participating TO's electric system during such suspension and, if applicable, any costs incurred in connection with the cancellation or suspension of material, equipment and labor contracts which the Participating TO cannot reasonably avoid; provided, however, that prior to canceling or suspending any such material, equipment or labor contract, the Participating TO shall obtain Interconnection Customer's authorization to do so.

The Participating TO shall invoice the Interconnection Customer for such costs pursuant to Article 12 and shall use due diligence to minimize its costs. In the event Interconnection Customer suspends work required under this LGIA pursuant to this Article 5.16, and has not requested the Participating TO to recommence the work or has not itself recommenced work required under this LGIA in time to ensure that the new projected Commercial Operation Date for the full Generating Facility Capacity of the Large Generating Facility is no more than three (3) years from the Commercial Operation Date identified in Appendix B hereto, this LGIA shall be deemed terminated and the Interconnection Customer's responsibility for costs will be determined in accordance with Section 2.4 of this LGIA. The suspension period shall begin on the date the suspension is requested, or the date of the written notice to the Participating TO and the CAISO, if no effective date is specified.

## **5.17 Taxes.**

**5.17.1 Interconnection Customer Payments Not Taxable.** The Parties intend that all payments or property transfers made by the Interconnection Customer to the Participating TO for the installation of the Participating TO's Interconnection Facilities and the Network Upgrades shall be non-taxable, either as contributions to capital, or as a refundable advance, in accordance with the Internal Revenue Code and any applicable state income tax laws and shall not be taxable as contributions in aid of construction or otherwise under the Internal Revenue Code and any applicable state income tax laws.

**5.17.2 Representations And Covenants.** In accordance with IRS Notice 2001-82 and IRS Notice 88-129, the Interconnection Customer represents and covenants that (i) ownership of the electricity generated at the Large Generating Facility will pass to another party prior to the transmission of

the electricity on the CAISO Controlled Grid, (ii) for income tax purposes, the amount of any payments and the cost of any property transferred to the Participating TO for the Participating TO's Interconnection Facilities will be capitalized by the Interconnection Customer as an intangible asset and recovered using the straight-line method over a useful life of twenty (20) years, and (iii) any portion of the Participating TO's Interconnection Facilities that is a "dual-use intertie," within the meaning of IRS Notice 88-129, is reasonably expected to carry only a de minimis amount of electricity in the direction of the Large Generating Facility. For this purpose, "de minimis amount" means no more than 5 percent of the total power flows in both directions, calculated in accordance with the "5 percent test" set forth in IRS Notice 88-129. This is not intended to be an exclusive list of the relevant conditions that must be met to conform to IRS requirements for non-taxable treatment.

At the Participating TO's request, the Interconnection Customer shall provide the Participating TO with a report from an independent engineer confirming its representation in clause (iii), above. The Participating TO represents and covenants that the cost of the Participating TO's Interconnection Facilities paid for by the Interconnection Customer without the possibility of refund or credit will have no net effect on the base upon which rates are determined.

**5.17.3 Indemnification for the Cost Consequence of Current Tax Liability Imposed Upon the Participating TO.** Notwithstanding Article 5.17.1, the Interconnection Customer shall protect, indemnify and hold harmless the Participating TO from the cost consequences of any current tax liability imposed against the Participating TO as the result of payments or property transfers made by the Interconnection Customer to the Participating TO under this LGIA for Interconnection Facilities, as well as any interest and penalties, other than interest and penalties attributable to any delay caused by the Participating TO.

The Participating TO shall not include a gross-up for the cost consequences of any current tax liability in the amounts it charges the Interconnection Customer under this LGIA unless (i) the Participating TO has determined, in good faith, that the payments or property transfers made by the Interconnection Customer to the Participating TO should be reported as income subject to taxation or (ii) any Governmental Authority directs the Participating TO to report payments or property as income subject to taxation; provided, however, that the Participating TO may require the Interconnection Customer to provide security for Interconnection Facilities, in a form reasonably acceptable to the Participating TO (such as a parental guarantee or a letter of credit), in an amount equal to the cost consequences of any current tax liability under this Article 5.17. The Interconnection Customer shall reimburse the

Participating TO for such costs on a fully grossed-up basis, in accordance with Article 5.17.4, within thirty (30) Calendar Days of receiving written notification from the Participating TO of the amount due, including detail about how the amount was calculated.

The indemnification obligation shall terminate at the earlier of (1) the expiration of the ten year testing period and the applicable statute of limitation, as it may be extended by the Participating TO upon request of the IRS, to keep these years open for audit or adjustment, or (2) the occurrence of a subsequent taxable event and the payment of any related indemnification obligations as contemplated by this Article 5.17.

5.17.4 Tax Gross-Up Amount. The Interconnection Customer's liability for the cost consequences of any current tax liability under this Article 5.17 shall be calculated on a fully grossed-up basis. Except as may otherwise be agreed to by the parties, this means that the Interconnection Customer will pay the Participating TO, in addition to the amount paid for the Interconnection Facilities and Network Upgrades, an amount equal to (1) the current taxes imposed on the Participating TO ("Current Taxes") on the excess of (a) the gross income realized by the Participating TO as a result of payments or property transfers made by the Interconnection Customer to the Participating TO under this LGIA (without regard to any payments under this Article 5.17) (the "Gross Income Amount") over (b) the present value of future tax deductions for depreciation that will be available as a result of such payments or property transfers (the "Present Value Depreciation Amount"), plus (2) an additional amount sufficient to permit the Participating TO to receive and retain, after the payment of all Current Taxes, an amount equal to the net amount described in clause (1).

For this purpose, (i) Current Taxes shall be computed based on the Participating TO's composite federal and state tax rates at the time the payments or property transfers are received and the Participating TO will be treated as being subject to tax at the highest marginal rates in effect at that time (the "Current Tax Rate"), and (ii) the Present Value Depreciation Amount shall be computed by discounting the Participating TO's anticipated tax depreciation deductions as a result of such payments or property transfers by the Participating TO's current weighted average cost of capital. Thus, the formula for calculating the Interconnection Customer's liability to the Participating TO pursuant to this Article 5.17.4 can be expressed as follows:  $(\text{Current Tax Rate} \times (\text{Gross Income Amount} - \text{Present Value of Tax Depreciation})) / (1 - \text{Current Tax Rate})$ . Interconnection Customer's estimated tax liability in the event taxes are imposed shall be stated in Appendix A, Interconnection Facilities, Network Upgrades and Distribution Upgrades.

5.17.5 Private Letter Ruling or Change or Clarification of Law. At the Interconnection Customer's request and expense, the Participating TO shall file with the IRS a request for a private letter ruling as to whether any property transferred or sums paid, or to be paid, by the Interconnection Customer to the Participating TO under this LGIA are subject to federal income taxation. The Interconnection Customer will prepare the initial draft of the request for a private letter ruling, and will certify under penalties of perjury that all facts represented in such request are true and accurate to the best of the Interconnection Customer's knowledge. The Participating TO and Interconnection Customer shall cooperate in good faith with respect to the submission of such request, provided, however, the Interconnection Customer and the Participating TO explicitly acknowledge (and nothing herein is intended to alter) Participating TO's obligation under law to certify that the facts presented in the ruling request are true, correct and complete.

The Participating TO shall keep the Interconnection Customer fully informed of the status of such request for a private letter ruling and shall execute either a privacy act waiver or a limited power of attorney, in a form acceptable to the IRS, that authorizes the Interconnection Customer to participate in all discussions with the IRS regarding such request for a private letter ruling. The Participating TO shall allow the Interconnection Customer to attend all meetings with IRS officials about the request and shall permit the Interconnection Customer to prepare the initial drafts of any follow-up letters in connection with the request.

5.17.6 Subsequent Taxable Events. If, within 10 years from the date on which the relevant Participating TO's Interconnection Facilities are placed in service, (i) the Interconnection Customer Breaches the covenants contained in Article 5.17.2, (ii) a "disqualification event" occurs within the meaning of IRS Notice 88-129, or (iii) this LGIA terminates and the Participating TO retains ownership of the Interconnection Facilities and Network Upgrades, the Interconnection Customer shall pay a tax gross-up for the cost consequences of any current tax liability imposed on the Participating TO, calculated using the methodology described in Article 5.17.4 and in accordance with IRS Notice 90-60.

5.17.7 Contests. In the event any Governmental Authority determines that the Participating TO's receipt of payments or property constitutes income that is subject to taxation, the Participating TO shall notify the Interconnection Customer, in writing, within thirty (30) Calendar Days of receiving notification of such determination by a Governmental Authority. Upon the timely written request by the Interconnection Customer and at the Interconnection Customer's sole expense, the Participating TO may appeal, protest, seek abatement of, or otherwise oppose such determination. Upon the Interconnection Customer's written request and



sole expense, the Participating TO may file a claim for refund with respect to any taxes paid under this Article 5.17, whether or not it has received such a determination. The Participating TO reserve the right to make all decisions with regard to the prosecution of such appeal, protest, abatement or other contest, including the selection of counsel and compromise or settlement of the claim, but the Participating TO shall keep the Interconnection Customer informed, shall consider in good faith suggestions from the Interconnection Customer about the conduct of the contest, and shall reasonably permit the Interconnection Customer or an Interconnection Customer representative to attend contest proceedings.

The Interconnection Customer shall pay to the Participating TO on a periodic basis, as invoiced by the Participating TO, the Participating TO's documented reasonable costs of prosecuting such appeal, protest, abatement or other contest, including any costs associated with obtaining the opinion of independent tax counsel described in this Article 5.17.7. The Participating TO may abandon any contest if the Interconnection Customer fails to provide payment to the Participating TO within thirty (30) Calendar Days of receiving such invoice.

At any time during the contest, the Participating TO may agree to a settlement either with the Interconnection Customer's consent or, if such consent is refused, after obtaining written advice from independent nationally-recognized tax counsel, selected by the Participating TO, but reasonably acceptable to the Interconnection Customer, that the proposed settlement represents a reasonable settlement given the hazards of litigation. The Interconnection Customer's obligation shall be based on the amount of the settlement agreed to by the Interconnection Customer, or if a higher amount, so much of the settlement that is supported by the written advice from nationally-recognized tax counsel selected under the terms of the preceding paragraph. The settlement amount shall be calculated on a fully grossed-up basis to cover any related cost consequences of the current tax liability. The Participating TO may also settle any tax controversy without receiving the Interconnection Customer's consent or any such written advice; however, any such settlement will relieve the Interconnection Customer from any obligation to indemnify the Participating TO for the tax at issue in the contest (unless the failure to obtain written advice is attributable to the Interconnection Customer's unreasonable refusal to the appointment of independent tax counsel).

- 5.17.8 Refund. In the event that (a) a private letter ruling is issued to the Participating TO which holds that any amount paid or the value of any property transferred by the Interconnection Customer to the Participating TO under the terms of this LGIA is not subject to federal income taxation, (b) any legislative change or administrative announcement, notice, ruling

or other determination makes it reasonably clear to the Participating TO in good faith that any amount paid or the value of any property transferred by the Interconnection Customer to the Participating TO under the terms of this LGIA is not taxable to the Participating TO, (c) any abatement, appeal, protest, or other contest results in a determination that any payments or transfers made by the Interconnection Customer to the Participating TO are not subject to federal income tax, or (d) if the Participating TO receives a refund from any taxing authority for any overpayment of tax attributable to any payment or property transfer made by the Interconnection Customer to the Participating TO pursuant to this LGIA, the Participating TO shall promptly refund to the Interconnection Customer the following:

(i) any payment made by Interconnection Customer under this Article 5.17 for taxes that is attributable to the amount determined to be non-taxable, together with interest thereon,

(ii) interest on any amounts paid by the Interconnection Customer to the Participating TO for such taxes which the Participating TO did not submit to the taxing authority, calculated in accordance with the methodology set forth in FERC's regulations at 18 C.F.R. §35.19a(a)(2)(iii) from the date payment was made by the Interconnection Customer to the date the Participating TO refunds such payment to the Interconnection Customer, and

(iii) with respect to any such taxes paid by the Participating TO, any refund or credit the Participating TO receives or to which it may be entitled from any Governmental Authority, interest (or that portion thereof attributable to the payment described in clause (i), above) owed to the Participating TO for such overpayment of taxes (including any reduction in interest otherwise payable by the Participating TO to any Governmental Authority resulting from an offset or credit); provided, however, that the Participating TO will remit such amount promptly to the Interconnection Customer only after and to the extent that the Participating TO has received a tax refund, credit or offset from any Governmental Authority for any applicable overpayment of income tax related to the Participating TO's Interconnection Facilities.

The intent of this provision is to leave the Parties, to the extent practicable, in the event that no taxes are due with respect to any payment for Interconnection Facilities and Network Upgrades hereunder, in the same position they would have been in had no such tax payments been made.

5.17.9 Taxes Other Than Income Taxes. Upon the timely request by the Interconnection Customer, and at the Interconnection Customer's sole expense, the CAISO or Participating TO may appeal, protest, seek

abatement of, or otherwise contest any tax (other than federal or state income tax) asserted or assessed against the CAISO or Participating TO for which the Interconnection Customer may be required to reimburse the CAISO or Participating TO under the terms of this LGIA. The Interconnection Customer shall pay to the Participating TO on a periodic basis, as invoiced by the Participating TO, the Participating TO's documented reasonable costs of prosecuting such appeal, protest, abatement, or other contest. The Interconnection Customer, the CAISO, and the Participating TO shall cooperate in good faith with respect to any such contest. Unless the payment of such taxes is a prerequisite to an appeal or abatement or cannot be deferred, no amount shall be payable by the Interconnection Customer to the CAISO or Participating TO for such taxes until they are assessed by a final, non-appealable order by any court or agency of competent jurisdiction. In the event that a tax payment is withheld and ultimately due and payable after appeal, the Interconnection Customer will be responsible for all taxes, interest and penalties, other than penalties attributable to any delay caused by the Participating TO.

**5.18 Tax Status.** Each Party shall cooperate with the others to maintain the other Parties' tax status. Nothing in this LGIA is intended to adversely affect the CAISO's or any Participating TO's tax exempt status with respect to the issuance of bonds including, but not limited to, Local Furnishing Bonds.

**5.19 Modification.**

**5.19.1 General.** The Interconnection Customer or the Participating TO may undertake modifications to its facilities, subject to the provisions of this LGIA and the CAISO Tariff. If a Party plans to undertake a modification that reasonably may be expected to affect the other Parties' facilities, that Party shall provide to the other Parties sufficient information regarding such modification so that the other Parties may evaluate the potential impact of such modification prior to commencement of the work. Such information shall be deemed to be confidential hereunder and shall include information concerning the timing of such modifications and whether such modifications are expected to interrupt the flow of electricity from the Large Generating Facility. The Party desiring to perform such work shall provide the relevant drawings, plans, and specifications to the other Parties at least ninety (90) Calendar Days in advance of the commencement of the work or such shorter period upon which the Parties may agree, which agreement shall not unreasonably be withheld, conditioned or delayed.

In the case of Large Generating Facility modifications that do not require the Interconnection Customer to submit an Interconnection Request, the CAISO or Participating TO shall provide, within thirty (30) Calendar Days (or such other time as the Parties may agree), an estimate of any

additional modifications to the CAISO Controlled Grid, Participating TO's Interconnection Facilities, Network Upgrades or Distribution Upgrades necessitated by such Interconnection Customer modification and a good faith estimate of the costs thereof. The Participating TO and the CAISO shall determine if a Large Generating Facility modification is a Material Modification in accordance with the LGIP.

5.19.2 Standards. Any additions, modifications, or replacements made to a Party's facilities shall be designed, constructed and operated in accordance with this LGIA and Good Utility Practice.

**5.19.3 Modification Costs.** The Interconnection Customer shall not be directly assigned the costs of any additions, modifications, or replacements that the Participating TO makes to the Participating TO's Interconnection Facilities or the Participating TO's Transmission System to facilitate the interconnection of a third party to the Participating TO's Interconnection Facilities or the Participating TO's Transmission System, or to provide transmission service to a third party under the CAISO Tariff. The Interconnection Customer shall be responsible for the costs of any additions, modifications, or replacements to the Interconnection Facilities that may be necessary to maintain or upgrade such Interconnection Facilities consistent with Applicable Laws and Regulations, Applicable Reliability Standards or Good Utility Practice.

## **ARTICLE 6. TESTING AND INSPECTION**

**6.1 Pre-Commercial Operation Date Testing and Modifications.** Prior to the Commercial Operation Date, the Participating TO shall test the Participating TO's Interconnection Facilities, Network Upgrades, and Distribution Upgrades and the Interconnection Customer shall test the Large Generating Facility and the Interconnection Customer's Interconnection Facilities to ensure their safe and reliable operation. Similar testing may be required after initial operation. Each Party shall make any modifications to its facilities that are found to be necessary as a result of such testing. The Interconnection Customer shall bear the cost of all such testing and modifications. The Interconnection Customer shall not commence initial parallel operation of an Electric Generating Unit with the Participating TO's Transmission System until the Participating TO provides prior written approval, which approval shall not be unreasonably withheld, for operation of such Electric Generating Unit. The Interconnection Customer shall generate test energy at the Large Generating Facility only if it has arranged for the delivery of such test energy.

**6.2 Post-Commercial Operation Date Testing and Modifications.** Each Party shall at its own expense perform routine inspection and testing of its facilities and equipment in accordance with Good Utility Practice as may be necessary to ensure the continued interconnection of the Large Generating Facility with the

Participating TO's Transmission System in a safe and reliable manner. Each Party shall have the right, upon advance written notice, to require reasonable additional testing of the other Party's facilities, at the requesting Party's expense, as may be in accordance with Good Utility Practice.

- 6.3 Right to Observe Testing.** Each Party shall notify the other Parties at least fourteen (14) Calendar Days in advance of its performance of tests of its Interconnection Facilities or Generating Facility. The other Parties have the right, at their own expense, to observe such testing.
- 6.4 Right to Inspect.** Each Party shall have the right, but shall have no obligation to: (i) observe another Party's tests and/or inspection of any of its System Protection Facilities and other protective equipment, including Power System Stabilizers; (ii) review the settings of another Party's System Protection Facilities and other protective equipment; and (iii) review another Party's maintenance records relative to the Interconnection Facilities, the System Protection Facilities and other protective equipment. A Party may exercise these rights from time to time as it deems necessary upon reasonable notice to the other Party. The exercise or non-exercise by a Party of any such rights shall not be construed as an endorsement or confirmation of any element or condition of the Interconnection Facilities or the System Protection Facilities or other protective equipment or the operation thereof, or as a warranty as to the fitness, safety, desirability, or reliability of same. Any information that a Party obtains through the exercise of any of its rights under this Article 6.4 shall be deemed to be Confidential Information and treated pursuant to Article 22 of this LGIA.

## **ARTICLE 7. METERING**

- 7.1 General.** Each Party shall comply with any Applicable Reliability Standards and the Applicable Reliability Council requirements. The Interconnection Customer and CAISO shall comply with the provisions of the CAISO Tariff regarding metering, including Section 10 of the CAISO Tariff. Unless otherwise agreed by the Participating TO and the Interconnection Customer, the Participating TO may install additional Metering Equipment at the Point of Interconnection prior to any operation of any Electric Generating Unit and shall own, operate, test and maintain such Metering Equipment. Power flows to and from the Large Generating Facility shall be measured at or, at the CAISO's or Participating TO's option for its respective Metering Equipment, compensated to, the Point of Interconnection. The CAISO shall provide metering quantities to the Interconnection Customer upon request in accordance with the CAISO Tariff by directly polling the CAISO's meter data acquisition system. The Interconnection Customer shall bear all reasonable documented costs associated with the purchase, installation, operation, testing and maintenance of the Metering Equipment.

- 7.2 Check Meters.** The Interconnection Customer, at its option and expense, may install and operate, on its premises and on its side of the Point of Interconnection, one or more check meters to check the CAISO-polled meters or the Participating TO's meters. Such check meters shall be for check purposes only and shall not be used for the measurement of power flows for purposes of this LGIA, except in the case that no other means are available on a temporary basis at the option of the CAISO or the Participating TO. The check meters shall be subject at all reasonable times to inspection and examination by the CAISO or Participating TO or their designees. The installation, operation and maintenance thereof shall be performed entirely by the Interconnection Customer in accordance with Good Utility Practice.
- 7.3 Participating TO Retail Metering.** The Participating TO may install retail revenue quality meters and associated equipment, pursuant to the Participating TO's applicable retail tariffs.

## **ARTICLE 8. COMMUNICATIONS**

- 8.1 Interconnection Customer Obligations.** The Interconnection Customer shall maintain satisfactory operating communications with the CAISO in accordance with the provisions of the CAISO Tariff and with the Participating TO's dispatcher or representative designated by the Participating TO. The Interconnection Customer shall provide standard voice line, dedicated voice line and facsimile communications at its Large Generating Facility control room or central dispatch facility through use of either the public telephone system, or a voice communications system that does not rely on the public telephone system. The Interconnection Customer shall also provide the dedicated data circuit(s) necessary to provide Interconnection Customer data to the CAISO and Participating TO as set forth in Appendix D, Security Arrangements Details. The data circuit(s) shall extend from the Large Generating Facility to the location(s) specified by the CAISO and Participating TO. Any required maintenance of such communications equipment shall be performed by the Interconnection Customer. Operational communications shall be activated and maintained under, but not be limited to, the following events: system paralleling or separation, scheduled and unscheduled shutdowns, equipment clearances, and hourly and daily load data.
- 8.2 Remote Terminal Unit.** Prior to the Initial Synchronization Date of each Electric Generating Unit, a Remote Terminal Unit, or equivalent data collection and transfer equipment acceptable to the Parties, shall be installed by the Interconnection Customer, or by the Participating TO at the Interconnection Customer's expense, to gather accumulated and instantaneous data to be telemetered to the location(s) designated by the CAISO and by the Participating TO through use of a dedicated point-to-point data circuit(s) as indicated in Article 8.1.

Telemetry to the CAISO shall be provided in accordance with the CAISO's technical standards for direct telemetry. For telemetry to the Participating TO, the communication protocol for the data circuit(s) shall be specified by the Participating TO. Instantaneous bi-directional real power and reactive power flow and any other required information must be telemetered directly to the location(s) specified by the Participating TO.

Each Party will promptly advise the other Parties if it detects or otherwise learns of any metering, telemetry or communications equipment errors or malfunctions that require the attention and/or correction by another Party. The Party owning such equipment shall correct such error or malfunction as soon as reasonably feasible.

- 8.3 No Annexation.** Any and all equipment placed on the premises of a Party shall be and remain the property of the Party providing such equipment regardless of the mode and manner of annexation or attachment to real property, unless otherwise mutually agreed by the Parties.

## ARTICLE 9. OPERATIONS

- 9.1 General.** Each Party shall comply with Applicable Reliability Standards and the Applicable Reliability Council requirements. Each Party shall provide to the other Party all information that may reasonably be required by the other Party to comply with Applicable Laws and Regulations and Applicable Reliability Standards.
- 9.2 Balancing Authority Area Notification.** At least three months before Initial Synchronization Date, the Interconnection Customer shall notify the CAISO and Participating TO in writing of the Balancing Authority Area in which the Large Generating Facility intends to be located. If the Interconnection Customer intends to locate the Large Generating Facility in a Balancing Authority Area other than the Balancing Authority Area within whose electrically metered boundaries the Large Generating Facility is located, and if permitted to do so by the relevant transmission tariffs, all necessary arrangements, including but not limited to those set forth in Article 7 and Article 8 of this LGIA, and remote Balancing Authority Area generator interchange agreements, if applicable, and the appropriate measures under such agreements, shall be executed and implemented prior to the placement of the Large Generating Facility in the other Balancing Authority Area.
- 9.3 CAISO and Participating TO Obligations.** The CAISO and Participating TO shall cause the Participating TO's Transmission System to be operated and controlled in a safe and reliable manner and in accordance with this LGIA. The Participating TO at the Interconnection Customer's expense shall cause the Participating TO's Interconnection Facilities to be operated, maintained and controlled in a safe and reliable manner and in accordance with this LGIA. The

CAISO and Participating TO may provide operating instructions to the Interconnection Customer consistent with this LGIA and Participating TO and CAISO operating protocols and procedures as they may change from time to time. The Participating TO and CAISO will consider changes to their operating protocols and procedures proposed by the Interconnection Customer.

**9.4 Interconnection Customer Obligations.** The Interconnection Customer shall at its own expense operate, maintain and control the Large Generating Facility and the Interconnection Customer's Interconnection Facilities in a safe and reliable manner and in accordance with this LGIA. The Interconnection Customer shall operate the Large Generating Facility and the Interconnection Customer's Interconnection Facilities in accordance with all applicable requirements of the Balancing Authority Area of which it is part, including such requirements as set forth in Appendix C, Interconnection Details, of this LGIA. Appendix C, Interconnection Details, will be modified to reflect changes to the requirements as they may change from time to time. A Party may request that another Party provide copies of the requirements set forth in Appendix C, Interconnection Details, of this LGIA. The Interconnection Customer shall not commence Commercial Operation of an Electric Generating Unit with the Participating TO's Transmission System until the Participating TO provides prior written approval, which approval shall not be unreasonably withheld, for operation of such Electric Generating Unit.

**9.5 Start-Up and Synchronization.** Consistent with the Parties' mutually acceptable procedures, the Interconnection Customer is responsible for the proper synchronization of each Electric Generating Unit to the CAISO Controlled Grid.

**9.6 Reactive Power.**

9.6.1 Power Factor Design Criteria. For all Generating Facilities other than Asynchronous Generating Facilities, the Interconnection Customer shall design the Large Generating Facility to maintain a composite power delivery at continuous rated power output at the terminals of the Electric Generating Unit at a power factor within the range of 0.95 leading to 0.90 lagging, unless the CAISO has established different requirements that apply to all generators in the Balancing Authority Area on a comparable basis. For Asynchronous Generating Facilities, the Interconnection Customer shall design the Large Generating Facility to maintain power factor criteria in accordance with Appendix H of this LGIA.

9.6.2 Voltage Schedules. Once the Interconnection Customer has synchronized an Electric Generating Unit with the CAISO Controlled Grid, the CAISO or Participating TO shall require the Interconnection Customer to maintain a voltage schedule by operating the Electric Generating Unit to produce or absorb reactive power within the design limitations of the



Electric Generating Unit set forth in Article 9.6.1 (Power Factor Design Criteria). CAISO's voltage schedules shall treat all sources of reactive power in the Balancing Authority Area in an equitable and not unduly discriminatory manner. The Participating TO shall exercise Reasonable Efforts to provide the Interconnection Customer with such schedules at least one (1) day in advance, and the CAISO or Participating TO may make changes to such schedules as necessary to maintain the reliability of the CAISO Controlled Grid or the Participating TO's electric system. The Interconnection Customer shall operate the Electric Generating Unit to maintain the specified output voltage or power factor within the design limitations of the Electric Generating Unit set forth in Article 9.6.1 (Power Factor Design Criteria), and as may be required by the CAISO to operate the Electric Generating Unit at a specific voltage schedule within the design limitations set forth in Article 9.6.1. If the Interconnection Customer is unable to maintain the specified voltage or power factor, it shall promptly notify the CAISO and the Participating TO.

**9.6.2.1      Governors and Regulators.** Whenever an Electric Generating Unit is operated in parallel with the CAISO Controlled Grid and the speed governors (if installed on the Electric Generating Unit pursuant to Good Utility Practice) and voltage regulators are capable of operation, the Interconnection Customer shall operate the Electric Generating Unit with its speed governors and voltage regulators in automatic operation. If the Electric Generating Unit's speed governors and voltage regulators are not capable of such automatic operation, the Interconnection Customer shall immediately notify the CAISO and the Participating TO and ensure that the Electric Generating Unit operates as specified in Article 9.6.2 through manual operation and that such Electric Generating Unit's reactive power production or absorption (measured in MVARs) are within the design capability of the Electric Generating Unit(s) and steady state stability limits. The Interconnection Customer shall restore the speed governors and voltage regulators to automatic operation as soon as possible. If the Large Generating Facility's speed governors and voltage regulators are improperly tuned or malfunctioning, the CAISO shall have the right to order the reduction in output or disconnection of the Large Generating Facility if the reliability of the CAISO Controlled Grid would be adversely affected. The Interconnection Customer shall not cause its Large Generating Facility to disconnect automatically or instantaneously from the CAISO Controlled Grid or trip any Electric Generating Unit comprising the Large Generating Facility for an under or over frequency condition unless the abnormal frequency condition persists for a time period beyond the limits set forth in ANSI/IEEE Standard C37.106, or such

other standard as applied to other generators in the Balancing Authority Area on a comparable basis.

9.6.3 Payment for Reactive Power. CAISO is required to pay the Interconnection Customer for reactive power that Interconnection Customer provides or absorbs from an Electric Generating Unit when the CAISO requests the Interconnection Customer to operate its Electric Generating Unit outside the range specified in Article 9.6.1, provided that if the CAISO pays other generators for reactive power service within the specified range, it must also pay the Interconnection Customer. Payments shall be pursuant to Article 11.6 or such other agreement to which the CAISO and Interconnection Customer have otherwise agreed.

## **9.7 Outages and Interruptions.**

### **9.7.1 Outages.**

**9.7.1.1 Outage Authority and Coordination.** Each Party may in accordance with Good Utility Practice in coordination with the other Parties remove from service any of its respective Interconnection Facilities or Network Upgrades that may impact another Party's facilities as necessary to perform maintenance or testing or to install or replace equipment. Absent an Emergency Condition, the Party scheduling a removal of such facility(ies) from service will use Reasonable Efforts to schedule such removal on a date and time mutually acceptable to all Parties. In all circumstances any Party planning to remove such facility(ies) from service shall use Reasonable Efforts to minimize the effect on the other Parties of such removal.

**9.7.1.2 Outage Schedules.** The CAISO shall post scheduled outages of CAISO Controlled Grid facilities in accordance with the provisions of the CAISO Tariff. The Interconnection Customer shall submit its planned maintenance schedules for the Large Generating Facility to the CAISO in accordance with the CAISO Tariff. The Interconnection Customer shall update its planned maintenance schedules in accordance with the CAISO Tariff. The CAISO may request the Interconnection Customer to reschedule its maintenance as necessary to maintain the reliability of the CAISO Controlled Grid in accordance with the CAISO Tariff. Such planned maintenance schedules and updates and changes to such schedules shall be provided by the Interconnection Customer to the Participating TO concurrently with their submittal to the CAISO. The CAISO shall compensate the Interconnection Customer for any additional direct costs that the Interconnection Customer incurs as a result of having to reschedule maintenance in accordance with the CAISO Tariff. The Interconnection Customer will not be eligible

to receive compensation, if during the twelve (12) months prior to the date of the scheduled maintenance, the Interconnection Customer had modified its schedule of maintenance activities.

**9.7.1.3 Outage Restoration.** If an outage on a Party's Interconnection Facilities or Network Upgrades adversely affects another Party's operations or facilities, the Party that owns or controls the facility that is out of service shall use Reasonable Efforts to promptly restore such facility(ies) to a normal operating condition consistent with the nature of the outage. The Party that owns or controls the facility that is out of service shall provide the other Parties, to the extent such information is known, information on the nature of the Emergency Condition, if the outage is caused by an Emergency Condition, an estimated time of restoration, and any corrective actions required. Initial verbal notice shall be followed up as soon as practicable with written notice explaining the nature of the outage, if requested by a Party, which may be provided by e-mail or facsimile.

9.7.2 Interruption of Service. If required by Good Utility Practice to do so, the CAISO or the Participating TO may require the Interconnection Customer to interrupt or reduce deliveries of electricity if such delivery of electricity could adversely affect the CAISO's or the Participating TO's ability to perform such activities as are necessary to safely and reliably operate and maintain the Participating TO's electric system or the CAISO Controlled Grid. The following provisions shall apply to any interruption or reduction permitted under this Article 9.7.2:

**9.7.2.1** The interruption or reduction shall continue only for so long as reasonably necessary under Good Utility Practice;

**9.7.2.2** Any such interruption or reduction shall be made on an equitable, non-discriminatory basis with respect to all generating facilities directly connected to the CAISO Controlled Grid, subject to any conditions specified in this LGIA;

**9.7.2.3** When the interruption or reduction must be made under circumstances which do not allow for advance notice, the CAISO or Participating TO, as applicable, shall notify the Interconnection Customer by telephone as soon as practicable of the reasons for the curtailment, interruption, or reduction, and, if known, its expected duration. Telephone notification shall be followed by written notification, if requested by the Interconnection Customer, as soon as practicable;

**9.7.2.4** Except during the existence of an Emergency Condition, the CAISO or Participating TO shall notify the Interconnection Customer in advance regarding the timing of such interruption or reduction and further notify the Interconnection Customer of the expected duration. The CAISO or Participating TO shall coordinate with the Interconnection Customer using Good Utility Practice to schedule the interruption or reduction during periods of least impact to the Interconnection Customer, the CAISO, and the Participating TO;

**9.7.2.5** The Parties shall cooperate and coordinate with each other to the extent necessary in order to restore the Large Generating Facility, Interconnection Facilities, the Participating TO's Transmission System, and the CAISO Controlled Grid to their normal operating state, consistent with system conditions and Good Utility Practice.

**9.7.3** Under-Frequency and Over Frequency Conditions. The CAISO Controlled Grid is designed to automatically activate a load-shed program as required by Applicable Reliability Standards and the Applicable Reliability Council in the event of an under-frequency system disturbance. The Interconnection Customer shall implement under-frequency and over-frequency protection set points for the Large Generating Facility as required by Applicable Reliability Standards and the Applicable Reliability Council to ensure "ride through" capability. Large Generating Facility response to frequency deviations of pre-determined magnitudes, both under-frequency and over-frequency deviations, shall be studied and coordinated with the Participating TO and CAISO in accordance with Good Utility Practice. The term "ride through" as used herein shall mean the ability of a Generating Facility to stay connected to and synchronized with the CAISO Controlled Grid during system disturbances within a range of under-frequency and over-frequency conditions, in accordance with Good Utility Practice. Asynchronous Generating Facilities shall be subject to frequency ride through capability requirements in accordance with Appendix H to this LGIA.

#### **9.7.4 System Protection and Other Control Requirements.**

**9.7.4.1 System Protection Facilities.** The Interconnection Customer shall, at its expense, install, operate and maintain System Protection Facilities as a part of the Large Generating Facility or the Interconnection Customer's Interconnection Facilities. The Participating TO shall install at the Interconnection Customer's expense any System Protection Facilities that may be required on the Participating TO's Interconnection Facilities or the Participating TO's Transmission System as a result of the interconnection of the

Large Generating Facility and the Interconnection Customer's Interconnection Facilities.

**9.7.4.2** The Participating TO's and Interconnection Customer's protection facilities shall be designed and coordinated with other systems in accordance with Applicable Reliability Standards, Applicable Reliability Council criteria, and Good Utility Practice.

**9.7.4.3** The Participating TO and Interconnection Customer shall each be responsible for protection of its facilities consistent with Good Utility Practice.

**9.7.4.4** The Participating TO's and Interconnection Customer's protective relay design shall incorporate the necessary test switches to perform the tests required in Article 6. The required test switches will be placed such that they allow operation of lockout relays while preventing breaker failure schemes from operating and causing unnecessary breaker operations and/or the tripping of the Interconnection Customer's Electric Generating Units.

**9.7.4.5** The Participating TO and Interconnection Customer will test, operate and maintain System Protection Facilities in accordance with Good Utility Practice and, if applicable, the requirements of the Participating TO's Interconnection Handbook.

**9.7.4.6** Prior to the in-service date, and again prior to the Commercial Operation Date, the Participating TO and Interconnection Customer or their agents shall perform a complete calibration test and functional trip test of the System Protection Facilities. At intervals suggested by Good Utility Practice, the standards and procedures of the Participating TO, including, if applicable, the requirements of the Participating TO's Interconnection Handbook, and following any apparent malfunction of the System Protection Facilities, each Party shall perform both calibration and functional trip tests of its System Protection Facilities. These tests do not require the tripping of any in-service generation unit. These tests do, however, require that all protective relays and lockout contacts be activated.

**9.7.5** Requirements for Protection. In compliance with Good Utility Practice and, if applicable, the requirements of the Participating TO's Interconnection Handbook, the Interconnection Customer shall provide, install, own, and maintain relays, circuit breakers and all other devices necessary to remove any fault contribution of the Large Generating Facility to any short circuit occurring on the Participating TO's

Transmission System not otherwise isolated by the Participating TO's equipment, such that the removal of the fault contribution shall be coordinated with the protective requirements of the Participating TO's Transmission System. Such protective equipment shall include, without limitation, a disconnecting device with fault current-interrupting capability located between the Large Generating Facility and the Participating TO's Transmission System at a site selected upon mutual agreement (not to be unreasonably withheld, conditioned or delayed) of the Parties. The Interconnection Customer shall be responsible for protection of the Large Generating Facility and the Interconnection Customer's other equipment from such conditions as negative sequence currents, over- or under-frequency, sudden load rejection, over- or under-voltage, and generator loss-of-field. The Interconnection Customer shall be solely responsible to disconnect the Large Generating Facility and the Interconnection Customer's other equipment if conditions on the CAISO Controlled Grid could adversely affect the Large Generating Facility.

9.7.6 Power Quality. Neither the Participating TO's nor the Interconnection Customer's facilities shall cause excessive voltage flicker nor introduce excessive distortion to the sinusoidal voltage or current waves as defined by ANSI Standard C84.1-1989, in accordance with IEEE Standard 519, any applicable superseding electric industry standard, or any alternative Applicable Reliability Standard or Applicable Reliability Council standard. In the event of a conflict among ANSI Standard C84.1-1989, any applicable superseding electric industry standard, or any alternative Applicable Reliability Standard or Applicable Reliability Council standard, the alternative Applicable Reliability Standard or Applicable Reliability Council standard shall control.

**9.8 Switching and Tagging Rules.** Each Party shall provide the other Parties a copy of its switching and tagging rules that are applicable to the other Parties' activities. Such switching and tagging rules shall be developed on a non-discriminatory basis. The Parties shall comply with applicable switching and tagging rules, as amended from time to time, in obtaining clearances for work or for switching operations on equipment.

**9.9 Use of Interconnection Facilities by Third Parties.**

9.9.1 Purpose of Interconnection Facilities. Except as may be required by Applicable Laws and Regulations, or as otherwise agreed to among the Parties, the Interconnection Facilities shall be constructed for the sole purpose of interconnecting the Large Generating Facility to the Participating TO's Transmission System and shall be used for no other purpose.

9.9.2 **Third Party Users.** If required by Applicable Laws and Regulations or if the Parties mutually agree, such agreement not to be unreasonably withheld, to allow one or more third parties to use the Participating TO's Interconnection Facilities, or any part thereof, the Interconnection Customer will be entitled to compensation for the capital expenses it incurred in connection with the Interconnection Facilities based upon the pro rata use of the Interconnection Facilities by the Participating TO, all third party users, and the Interconnection Customer, in accordance with Applicable Laws and Regulations or upon some other mutually-agreed upon methodology. In addition, cost responsibility for ongoing costs, including operation and maintenance costs associated with the Interconnection Facilities, will be allocated between the Interconnection Customer and any third party users based upon the pro rata use of the Interconnection Facilities by the Participating TO, all third party users, and the Interconnection Customer, in accordance with Applicable Laws and Regulations or upon some other mutually agreed upon methodology. If the issue of such compensation or allocation cannot be resolved through such negotiations, it shall be submitted to FERC for resolution.

**9.10 Disturbance Analysis Data Exchange.** The Parties will cooperate with one another in the analysis of disturbances to either the Large Generating Facility or the CAISO Controlled Grid by gathering and providing access to any information relating to any disturbance, including information from oscillography, protective relay targets, breaker operations and sequence of events records, and any disturbance information required by Good Utility Practice.

## **ARTICLE 10. MAINTENANCE**

**10.1 Participating TO Obligations.** The Participating TO shall maintain the Participating TO's Transmission System and the Participating TO's Interconnection Facilities in a safe and reliable manner and in accordance with this LGIA.

**10.2 Interconnection Customer Obligations.** The Interconnection Customer shall maintain the Large Generating Facility and the Interconnection Customer's Interconnection Facilities in a safe and reliable manner and in accordance with this LGIA.

**10.3 Coordination.** The Parties shall confer regularly to coordinate the planning, scheduling and performance of preventive and corrective maintenance on the Large Generating Facility and the Interconnection Facilities.

**10.4 Secondary Systems.** The Participating TO and Interconnection Customer shall cooperate with the other Parties in the inspection, maintenance, and testing of control or power circuits that operate below 600 volts, AC or DC, including, but not limited to, any hardware, control or protective devices, cables, conductors,

electric raceways, secondary equipment panels, transducers, batteries, chargers, and voltage and current transformers that directly affect the operation of a Party's facilities and equipment which may reasonably be expected to impact the other Parties. Each Party shall provide advance notice to the other Parties before undertaking any work on such circuits, especially on electrical circuits involving circuit breaker trip and close contacts, current transformers, or potential transformers.

- 10.5 Operating and Maintenance Expenses.** Subject to the provisions herein addressing the use of facilities by others, and except for operations and maintenance expenses associated with modifications made for providing interconnection or transmission service to a third party and such third party pays for such expenses, the Interconnection Customer shall be responsible for all reasonable expenses including overheads, associated with: (1) owning, operating, maintaining, repairing, and replacing the Interconnection Customer's Interconnection Facilities; and (2) operation, maintenance, repair and replacement of the Participating TO's Interconnection Facilities.

## **ARTICLE 11. PERFORMANCE OBLIGATION**

- 11.1 Interconnection Customer's Interconnection Facilities.** The Interconnection Customer shall design, procure, construct, install, own and/or control the Interconnection Customer's Interconnection Facilities described in Appendix A at its sole expense.
- 11.2 Participating TO's Interconnection Facilities.** The Participating TO shall design, procure, construct, install, own and/or control the Participating TO's Interconnection Facilities described in Appendix A at the sole expense of the Interconnection Customer. Unless the Participating TO elects to fund the capital for the Participating TO's Interconnection Facilities, they shall be solely funded by the Interconnection Customer.
- 11.3 Network Upgrades and Distribution Upgrades.** The Participating TO shall design, procure, construct, install, and own the Network Upgrades and Distribution Upgrades described in Appendix A. The Interconnection Customer shall be responsible for all costs related to Distribution Upgrades. Unless the Participating TO elects to fund the capital for the Distribution Upgrades and Network Upgrades, they shall be funded by the Interconnection Customer in an amount determined pursuant to the methodology set forth in Section 13 of the LGIP. This specific amount is set forth in Appendix G to this LGIA.
- 11.4 Transmission Credits.** No later than thirty (30) Calendar Days prior to the Commercial Operation Date, the Interconnection Customer may make a one-time election by written notice to the CAISO and the Participating TO to receive Congestion Revenue Rights as defined in and as available under the CAISO



Tariff at the time of the election in accordance with the CAISO Tariff, in lieu of a refund of the cost of Network Upgrades in accordance with Article 11.4.1.

11.4.1 Repayment of Amounts Advanced for Network Upgrades. Upon the Commercial Operation Date, the Interconnection Customer shall be entitled to a repayment, equal to the total amount paid to the Participating TO for the costs of Network Upgrades for which it is responsible, as set forth in Appendix G. Such amount shall include any tax gross-up or other tax-related payments associated with Network Upgrades not refunded to the Interconnection Customer pursuant to Article 5.17.8 or otherwise, and shall be paid to the Interconnection Customer by the Participating TO on a dollar-for-dollar basis either through (1) direct payments made on a levelized basis over the five-year period commencing on the Commercial Operation Date; or (2) any alternative payment schedule that is mutually agreeable to the Interconnection Customer and Participating TO, provided that such amount is paid within five (5) years from the Commercial Operation Date. Notwithstanding the foregoing, if this LGIA terminates within five (5) years from the Commercial Operation Date, the Participating TO's obligation to pay refunds to the Interconnection Customer shall cease as of the date of termination. Any repayment shall include interest calculated in accordance with the methodology set forth in FERC's regulations at 18 C.F.R. §35.19a(a)(2)(iii) from the date of any payment for Network Upgrades through the date on which the Interconnection Customer receives a repayment of such payment. Interest shall continue to accrue on the repayment obligation so long as this LGIA is in effect. The Interconnection Customer may assign such repayment rights to any person.

If the Large Generating Facility fails to achieve Commercial Operation, but it or another Generating Facility is later constructed and makes use of the Network Upgrades, the Participating TO shall at that time reimburse Interconnection Customer for the amounts advanced for the Network Upgrades. Before any such reimbursement can occur, the Interconnection Customer, or the entity that ultimately constructs the Generating Facility, if different, is responsible for identifying and demonstrating to the Participating TO the appropriate entity to which reimbursement must be made in order to implement the intent of this reimbursement obligation.

11.4.2 Special Provisions for Affected Systems. The Interconnection Customer shall enter into an agreement with the owner of the Affected System and/or other affected owners of portions of the CAISO Controlled Grid, as applicable, in accordance with the LGIP. Such agreement shall specify the terms governing payments to be made by the Interconnection Customer to the owner of the Affected System and/or other affected owners of portions of the CAISO Controlled Grid as well as the repayment

by the owner of the Affected System and/or other affected owners of portions of the CAISO Controlled Grid. In no event shall the Participating TO be responsible for the repayment for any facilities that are not part of the Participating TO's Transmission System. In the event the Participating TO is a joint owner with an Affected System or with any other co-owner of a facility affected by the Large Generating Facility, the Participating TO's obligation to reimburse the Interconnection Customer for payments made to address the impacts of the Large Generating Facility on the system shall not exceed the proportionate amount of the cost of any upgrades attributable to the proportion of the jointly-owned facility owned by the Participating TO.

11.4.3 Notwithstanding any other provision of this LGIA, nothing herein shall be construed as relinquishing or foreclosing any rights, including but not limited to firm transmission rights, capacity rights, Congestion Revenue Rights, or transmission credits, that the Interconnection Customer shall be entitled to, now or in the future under any other agreement or tariff as a result of, or otherwise associated with, the transmission capacity, if any, created by the Network Upgrades, including the right to obtain cash reimbursements, merchant transmission Congestion Revenue Rights in accordance with Section 36.11 of the CAISO Tariff, or transmission credits for transmission service that is not associated with the Large Generating Facility.

**11.5 Provision of Interconnection Financial Security.** The Interconnection Customer is obligated to provide all necessary Interconnection Financial Security required under Section 9 of the LGIP in a manner acceptable under Section 9 of the LGIP. Failure to satisfy the LGIP's requirements for the provision of Interconnection Financial Security shall result in the Interconnection Request being deemed withdrawn and subject to LGIP Section 3.8.

**11.6 Interconnection Customer Compensation.** If the CAISO requests or directs the Interconnection Customer to provide a service pursuant to Articles 9.6.3 (Payment for Reactive Power) or 13.5.1 of this LGIA, the CAISO shall compensate the Interconnection Customer in accordance with the CAISO Tariff.

**11.6.1 Interconnection Customer Compensation for Actions During Emergency Condition.** The CAISO shall compensate the Interconnection Customer in accordance with the CAISO Tariff for its provision of real and reactive power and other Emergency Condition services that the Interconnection Customer provides to support the CAISO Controlled Grid during an Emergency Condition in accordance with Article 11.6.

## **ARTICLE 12. INVOICE**

- 12.1 General.** The Participating TO shall submit to the Interconnection Customer, on a monthly basis, invoices of amounts due pursuant to this LGIA for the preceding month. Each invoice shall state the month to which the invoice applies and fully describe the services and equipment provided. The Parties may discharge mutual debts and payment obligations due and owing to each other on the same date through netting, in which case all amounts a Party owes to the other Party under this LGIA, including interest payments or credits, shall be netted so that only the net amount remaining due shall be paid by the owing Party. Notwithstanding the foregoing, any invoices between the CAISO and another Party shall be submitted and paid in accordance with the CAISO Tariff.
- 12.2 Final Invoice.** As soon as reasonably practicable, but within twelve months after completion of the construction of the Participating TO's Interconnection Facilities, Network Upgrades, and Distribution Upgrades, the Participating TO shall provide an invoice of the final cost of the construction of the Participating TO's Interconnection Facilities, Network Upgrades, and Distribution Upgrades, and shall set forth such costs in sufficient detail to enable the Interconnection Customer to compare the actual costs with the estimates and to ascertain deviations, if any, from the cost estimates. With respect to costs associated with the Participating TO's Interconnection Facilities and Distribution Upgrades, the Participating TO shall refund to the Interconnection Customer any amount by which the actual payment by the Interconnection Customer for estimated costs exceeds the actual costs of construction within thirty (30) Calendar Days of the issuance of such final construction invoice; or, in the event the actual costs of construction exceed the Interconnection Customer's actual payment for estimated costs, then the Interconnection Customer shall pay to the Participating TO any amount by which the actual costs of construction exceed the actual payment by the Interconnection Customer for estimated costs within thirty (30) Calendar Days of the issuance of such final construction invoice. With respect to costs associated with Network Upgrades, the Participating TO shall refund to the Interconnection Customer any amount by which the actual payment by the Interconnection Customer for estimated costs exceeds the actual costs of construction multiplied by the Interconnection Customer's percentage share of those costs, as set forth in Appendix G to this LGIA within thirty (30) Calendar Days of the issuance of such final construction invoice. In the event the actual costs of construction multiplied by the Interconnection Customer's percentage share of those costs exceed the Interconnection Customer's actual payment for estimated costs, then the Participating TO shall recover such difference through its transmission service rates.
- 12.3 Payment.** Invoices shall be rendered to the Interconnection Customer at the address specified in Appendix F. The Interconnection Customer shall pay, or Participating TO shall refund, the amounts due within thirty (30) Calendar Days of the Interconnection Customer's receipt of the invoice. All payments shall be made in immediately available funds payable to the Interconnection Customer or Participating TO, or by wire transfer to a bank named and account designated by

the invoicing Interconnection Customer or Participating TO. Payment of invoices by any Party will not constitute a waiver of any rights or claims any Party may have under this LGIA.

- 12.4 Disputes.** In the event of a billing dispute between the Interconnection Customer and the Participating TO, the Participating TO and the CAISO shall continue to provide Interconnection Service under this LGIA as long as the Interconnection Customer: (i) continues to make all payments not in dispute; and (ii) pays to the Participating TO or into an independent escrow account the portion of the invoice in dispute, pending resolution of such dispute. If the Interconnection Customer fails to meet these two requirements for continuation of service, then the Participating TO may provide notice to the Interconnection Customer of a Default pursuant to Article 17. Within thirty (30) Calendar Days after the resolution of the dispute, the Party that owes money to the other Party shall pay the amount due with interest calculated in accordance with the methodology set forth in FERC's Regulations at 18 C.F.R. § 35.19a(a)(2)(iii). Notwithstanding the foregoing, any billing dispute between the CAISO and another Party shall be resolved in accordance with the provisions of Article 27 of this LGIA.

## ARTICLE 13. EMERGENCIES

### 13.1 [Reserved]

- 13.2 Obligations.** Each Party shall comply with the Emergency Condition procedures of the CAISO, NERC, the Applicable Reliability Council, Applicable Reliability Standards, Applicable Laws and Regulations, and any emergency procedures set forth in this LGIA.

- 13.3 Notice.** The Participating TO or the CAISO shall notify the Interconnection Customer promptly when it becomes aware of an Emergency Condition that affects the Participating TO's Interconnection Facilities or Distribution System or the CAISO Controlled Grid, respectively, that may reasonably be expected to affect the Interconnection Customer's operation of the Large Generating Facility or the Interconnection Customer's Interconnection Facilities. The Interconnection Customer shall notify the Participating TO and the CAISO promptly when it becomes aware of an Emergency Condition that affects the Large Generating Facility or the Interconnection Customer's Interconnection Facilities that may reasonably be expected to affect the CAISO Controlled Grid or the Participating TO's Interconnection Facilities. To the extent information is known, the notification shall describe the Emergency Condition, the extent of the damage or deficiency, the expected effect on the operation of the Interconnection Customer's or Participating TO's facilities and operations, its anticipated duration and the corrective action taken and/or to be taken. The initial notice shall be followed as soon as practicable with written notice, if requested by a Party, which

may be provided by electronic mail or facsimile, or in the case of the CAISO may be publicly posted on the CAISO's internet web site.

**13.4 Immediate Action.** Unless, in the Interconnection Customer's reasonable judgment, immediate action is required, the Interconnection Customer shall obtain the consent of the CAISO and the Participating TO, such consent to not be unreasonably withheld, prior to performing any manual switching operations at the Large Generating Facility or the Interconnection Customer's Interconnection Facilities in response to an Emergency Condition declared by the Participating TO or CAISO or in response to any other emergency condition.

**13.5 CAISO and Participating TO Authority.**

13.5.1 General. The CAISO and Participating TO may take whatever actions or inactions, including issuance of dispatch instructions, with regard to the CAISO Controlled Grid or the Participating TO's Interconnection Facilities or Distribution System they deem necessary during an Emergency Condition in order to (i) preserve public health and safety, (ii) preserve the reliability of the CAISO Controlled Grid or the Participating TO's Interconnection Facilities or Distribution System, and (iii) limit or prevent damage, and (iv) expedite restoration of service.

The Participating TO and the CAISO shall use Reasonable Efforts to minimize the effect of such actions or inactions on the Large Generating Facility or the Interconnection Customer's Interconnection Facilities. The Participating TO or the CAISO may, on the basis of technical considerations, require the Large Generating Facility to mitigate an Emergency Condition by taking actions necessary and limited in scope to remedy the Emergency Condition, including, but not limited to, directing the Interconnection Customer to shut-down, start-up, increase or decrease the real or reactive power output of the Large Generating Facility; implementing a reduction or disconnection pursuant to Article 13.5.2; directing the Interconnection Customer to assist with black start (if available) or restoration efforts; or altering the outage schedules of the Large Generating Facility and the Interconnection Customer's Interconnection Facilities. Interconnection Customer shall comply with all of the CAISO's and Participating TO's operating instructions concerning Large Generating Facility real power and reactive power output within the manufacturer's design limitations of the Large Generating Facility's equipment that is in service and physically available for operation at the time, in compliance with Applicable Laws and Regulations.

13.5.2 Reduction and Disconnection. The Participating TO or the CAISO may reduce Interconnection Service or disconnect the Large Generating Facility or the Interconnection Customer's Interconnection Facilities when such reduction or disconnection is necessary under Good Utility Practice

due to Emergency Conditions. These rights are separate and distinct from any right of curtailment of the CAISO pursuant to the CAISO Tariff. When the CAISO or Participating TO can schedule the reduction or disconnection in advance, the CAISO or Participating TO shall notify the Interconnection Customer of the reasons, timing and expected duration of the reduction or disconnection. The CAISO or Participating TO shall coordinate with the Interconnection Customer using Good Utility Practice to schedule the reduction or disconnection during periods of least impact to the Interconnection Customer and the CAISO and Participating TO. Any reduction or disconnection shall continue only for so long as reasonably necessary under Good Utility Practice. The Parties shall cooperate with each other to restore the Large Generating Facility, the Interconnection Facilities, and the CAISO Controlled Grid to their normal operating state as soon as practicable consistent with Good Utility Practice.

**13.6 Interconnection Customer Authority.** Consistent with Good Utility Practice, this LGIA, and the CAISO Tariff, the Interconnection Customer may take actions or inactions with regard to the Large Generating Facility or the Interconnection Customer's Interconnection Facilities during an Emergency Condition in order to (i) preserve public health and safety, (ii) preserve the reliability of the Large Generating Facility or the Interconnection Customer's Interconnection Facilities, (iii) limit or prevent damage, and (iv) expedite restoration of service. Interconnection Customer shall use Reasonable Efforts to minimize the effect of such actions or inactions on the CAISO Controlled Grid and the Participating TO's Interconnection Facilities. The CAISO and Participating TO shall use Reasonable Efforts to assist Interconnection Customer in such actions.

**13.7 Limited Liability.** Except as otherwise provided in Article 11.6.1 of this LGIA, no Party shall be liable to any other Party for any action it takes in responding to an Emergency Condition so long as such action is made in good faith and is consistent with Good Utility Practice.

## **ARTICLE 14. REGULATORY REQUIREMENTS AND GOVERNING LAW**

**14.1 Regulatory Requirements.** Each Party's obligations under this LGIA shall be subject to its receipt of any required approval or certificate from one or more Governmental Authorities in the form and substance satisfactory to the applying Party, or the Party making any required filings with, or providing notice to, such Governmental Authorities, and the expiration of any time period associated therewith. Each Party shall in good faith seek and use its Reasonable Efforts to obtain such other approvals. Nothing in this LGIA shall require the Interconnection Customer to take any action that could result in its inability to obtain, or its loss of, status or exemption under the Federal Power Act or the Public Utility Holding Company Act of 1935, as amended, or the Public Utility Regulatory Policies Act of 1978, or the Energy Policy Act of 2005.

## **14.2 Governing Law.**

14.2.1 The validity, interpretation and performance of this LGIA and each of its provisions shall be governed by the laws of the state where the Point of Interconnection is located, without regard to its conflicts of law principles.

14.2.2 This LGIA is subject to all Applicable Laws and Regulations.

14.2.3 Each Party expressly reserves the right to seek changes in, appeal, or otherwise contest any laws, orders, rules, or regulations of a Governmental Authority.

## **ARTICLE 15. NOTICES**

**15.1 General.** Unless otherwise provided in this LGIA, any notice, demand or request required or permitted to be given by a Party to another and any instrument required or permitted to be tendered or delivered by a Party in writing to another shall be effective when delivered and may be so given, tendered or delivered, by recognized national courier, or by depositing the same with the United States Postal Service with postage prepaid, for delivery by certified or registered mail, addressed to the Party, or personally delivered to the Party, at the address set out in Appendix F, Addresses for Delivery of Notices and Billings.

A Party must update the information in Appendix F as information changes. A Party may change the notice information in this LGIA by giving five (5) Business Days written notice prior to the effective date of the change. Such changes shall not constitute an amendment to this LGIA.

**15.2 Billings and Payments.** Billings and payments shall be sent to the addresses set out in Appendix F.

**15.3 Alternative Forms of Notice.** Any notice or request required or permitted to be given by a Party to another and not required by this LGIA to be given in writing may be so given by telephone, facsimile or e-mail to the telephone numbers and e-mail addresses set out in Appendix F.

**15.4 Operations and Maintenance Notice.** Each Party shall notify the other Parties in writing of the identity of the person(s) that it designates as the point(s) of contact with respect to the implementation of Articles 9 and 10.

## **ARTICLE 16. FORCE MAJEURE**

### **16.1 Force Majeure.**

16.1.1 Economic hardship is not considered a Force Majeure event.

16.1.2 No Party shall be considered to be in Default with respect to any obligation hereunder, (including obligations under Article 4), other than the obligation to pay money when due, if prevented from fulfilling such obligation by Force Majeure. A Party unable to fulfill any obligation hereunder (other than an obligation to pay money when due) by reason of Force Majeure shall give notice and the full particulars of such Force Majeure to the other Party in writing or by telephone as soon as reasonably possible after the occurrence of the cause relied upon. Telephone notices given pursuant to this Article shall be confirmed in writing as soon as reasonably possible and shall specifically state full particulars of the Force Majeure, the time and date when the Force Majeure occurred and when the Force Majeure is reasonably expected to cease. The Party affected shall exercise due diligence to remove such disability with reasonable dispatch, but shall not be required to accede or agree to any provision not satisfactory to it in order to settle and terminate a strike or other labor disturbance.

## **ARTICLE 17. DEFAULT**

### **17.1 Default.**

17.1.1 General. No Default shall exist where such failure to discharge an obligation (other than the payment of money) is the result of Force Majeure as defined in this LGIA or the result of an act or omission of the other Party. Upon a Breach, the affected non-Breaching Party(ies) shall give written notice of such Breach to the Breaching Party. Except as provided in Article 17.1.2, the Breaching Party shall have thirty (30) Calendar Days from receipt of the Default notice within which to cure such Breach; provided however, if such Breach is not capable of cure within thirty (30) Calendar Days, the Breaching Party shall commence such cure within thirty (30) Calendar Days after notice and continuously and diligently complete such cure within ninety (90) Calendar Days from receipt of the Default notice; and, if cured within such time, the Breach specified in such notice shall cease to exist.

17.1.2 Right to Terminate. If a Breach is not cured as provided in this Article, or if a Breach is not capable of being cured within the period provided for herein, the affected non-Breaching Party(ies) shall have the right to



declare a Default and terminate this LGIA by written notice at any time until cure occurs, and be relieved of any further obligation hereunder and, whether or not such Party(ies) terminates this LGIA, to recover from the Breaching Party all amounts due hereunder, plus all other damages and remedies to which it is entitled at law or in equity. The provisions of this Article will survive termination of this LGIA.

## **ARTICLE 18. INDEMNITY, CONSEQUENTIAL DAMAGES AND INSURANCE**

**18.1 Indemnity.** Each Party shall at all times indemnify, defend, and hold the other Parties harmless from, any and all Losses arising out of or resulting from another Party's action or inactions of its obligations under this LGIA on behalf of the indemnifying Party, except in cases of gross negligence or intentional wrongdoing by the Indemnified Party.

18.1.1 Indemnified Party. If an Indemnified Party is entitled to indemnification under this Article 18 as a result of a claim by a third party, and the Indemnifying Party fails, after notice and reasonable opportunity to proceed under Article 18.1, to assume the defense of such claim, such Indemnified Party may at the expense of the Indemnifying Party contest, settle or consent to the entry of any judgment with respect to, or pay in full, such claim.

18.1.2 Indemnifying Party. If an Indemnifying Party is obligated to indemnify and hold any Indemnified Party harmless under this Article 18, the amount owing to the Indemnified Party shall be the amount of such Indemnified Party's actual Loss, net of any insurance or other recovery.

18.1.3 **Indemnity Procedures.** Promptly after receipt by an Indemnified Party of any claim or notice of the commencement of any action or administrative or legal proceeding or investigation as to which the indemnity provided for in Article 18.1 may apply, the Indemnified Party shall notify the Indemnifying Party of such fact. Any failure of or delay in such notification shall not affect a Party's indemnification obligation unless such failure or delay is materially prejudicial to the indemnifying Party.

The Indemnifying Party shall have the right to assume the defense thereof with counsel designated by such Indemnifying Party and reasonably satisfactory to the Indemnified Party. If the defendants in any such action include one or more Indemnified Parties and the Indemnifying Party and if the Indemnified Party reasonably concludes that there may be legal defenses available to it and/or other Indemnified Parties which are different from or additional to those available to the Indemnifying Party, the Indemnified Party shall have the right to select separate counsel to assert such legal defenses and to otherwise participate in the defense

of such action on its own behalf. In such instances, the Indemnifying Party shall only be required to pay the fees and expenses of one additional attorney to represent an Indemnified Party or Indemnified Parties having such differing or additional legal defenses.

The Indemnified Party shall be entitled, at its expense, to participate in any such action, suit or proceeding, the defense of which has been assumed by the Indemnifying Party. Notwithstanding the foregoing, the Indemnifying Party (i) shall not be entitled to assume and control the defense of any such action, suit or proceedings if and to the extent that, in the opinion of the Indemnified Party and its counsel, such action, suit or proceeding involves the potential imposition of criminal liability on the Indemnified Party, or there exists a conflict or adversity of interest between the Indemnified Party and the Indemnifying Party, in such event the Indemnifying Party shall pay the reasonable expenses of the Indemnified Party, and (ii) shall not settle or consent to the entry of any judgment in any action, suit or proceeding without the consent of the Indemnified Party, which shall not be unreasonably withheld, conditioned or delayed.

**18.2 Consequential Damages.** Other than the liquidated damages heretofore described in Article 5.3, in no event shall any Party be liable under any provision of this LGIA for any losses, damages, costs or expenses for any special, indirect, incidental, consequential, or punitive damages, including but not limited to loss of profit or revenue, loss of the use of equipment, cost of capital, cost of temporary equipment or services, whether based in whole or in part in contract, in tort, including negligence, strict liability, or any other theory of liability; provided, however, that damages for which a Party may be liable to another Party under another agreement will not be considered to be special, indirect, incidental, or consequential damages hereunder.

**18.3 Insurance.** Each Party shall, at its own expense, maintain in force throughout the period of this LGIA, and until released by the other Parties, the following minimum insurance coverages, with insurers rated no less than A- (with a minimum size rating of VII) by Bests' Insurance Guide and Key Ratings and authorized to do business in the state where the Point of Interconnection is located, except in the case of the CAISO, the State of California:

18.3.1 Employer's Liability and Workers' Compensation Insurance providing statutory benefits in accordance with the laws and regulations of the state in which the Point of Interconnection is located, except in the case of the CAISO, the State of California.

18.3.2 Commercial General Liability Insurance including premises and operations, personal injury, broad form property damage, broad form blanket contractual liability coverage (including coverage for the

contractual indemnification) products and completed operations coverage, coverage for explosion, collapse and underground hazards, independent contractors coverage, coverage for pollution to the extent normally available and punitive damages to the extent normally available and a cross liability endorsement, with minimum limits of One Million Dollars (\$1,000,000) per occurrence/One Million Dollars (\$1,000,000) aggregate combined single limit for personal injury, bodily injury, including death and property damage.

- 18.3.3 Business Automobile Liability Insurance for coverage of owned and non-owned and hired vehicles, trailers or semi-trailers designed for travel on public roads, with a minimum, combined single limit of One Million Dollars (\$1,000,000) per occurrence for bodily injury, including death, and property damage.
- 18.3.4 Excess Public Liability Insurance over and above the Employer's Liability Commercial General Liability and Business Automobile Liability Insurance coverage, with a minimum combined single limit of Twenty Million Dollars (\$20,000,000) per occurrence/Twenty Million Dollars (\$20,000,000) aggregate.
- 18.3.5 The Commercial General Liability Insurance, Business Automobile Insurance and Excess Public Liability Insurance policies shall name the other Parties, their parents, associated and Affiliate companies and their respective directors, officers, agents, servants and employees ("Other Party Group") as additional insured. All policies shall contain provisions whereby the insurers waive all rights of subrogation in accordance with the provisions of this LGIA against the Other Party Group and provide thirty (30) Calendar Days advance written notice to the Other Party Group prior to anniversary date of cancellation or any material change in coverage or condition.
- 18.3.6 The Commercial General Liability Insurance, Business Automobile Liability Insurance and Excess Public Liability Insurance policies shall contain provisions that specify that the policies are primary and shall apply to such extent without consideration for other policies separately carried and shall state that each insured is provided coverage as though a separate policy had been issued to each, except the insurer's liability shall not be increased beyond the amount for which the insurer would have been liable had only one insured been covered. Each Party shall be responsible for its respective deductibles or retentions.
- 18.3.7 The Commercial General Liability Insurance, Business Automobile Liability Insurance and Excess Public Liability Insurance policies, if written on a Claims First Made Basis, shall be maintained in full force and effect for two (2) years after termination of this LGIA, which

coverage may be in the form of tail coverage or extended reporting period coverage if agreed by the Parties.

- 18.3.8 The requirements contained herein as to the types and limits of all insurance to be maintained by the Parties are not intended to and shall not in any manner, limit or qualify the liabilities and obligations assumed by the Parties under this LGIA.
- 18.3.9 Within ten (10) Calendar Days following execution of this LGIA, and as soon as practicable after the end of each fiscal year or at the renewal of the insurance policy and in any event within ninety (90) Calendar Days thereafter, each Party shall provide certification of all insurance required in this LGIA, executed by each insurer or by an authorized representative of each insurer.
- 18.3.10 Notwithstanding the foregoing, each Party may self-insure to meet the minimum insurance requirements of Articles 18.3.2 through 18.3.8 to the extent it maintains a self-insurance program; provided that, such Party's senior unsecured debt or issuer rating is BBB-, or better, as rated by Standard & Poor's and that its self-insurance program meets the minimum insurance requirements of Articles 18.3.2 through 18.3.8. For any period of time that a Party's senior unsecured debt rating and issuer rating are both unrated by Standard & Poor's or are both rated at less than BBB- by Standard & Poor's, such Party shall comply with the insurance requirements applicable to it under Articles 18.3.2 through 18.3.9. In the event that a Party is permitted to self-insure pursuant to this Article 18.3.10, it shall notify the other Parties that it meets the requirements to self-insure and that its self-insurance program meets the minimum insurance requirements in a manner consistent with that specified in Article 18.3.9.
- 18.3.11 The Parties agree to report to each other in writing as soon as practical all accidents or occurrences resulting in injuries to any person, including death, and any property damage arising out of this LGIA.

## **ARTICLE 19. ASSIGNMENT**

- 19.1 Assignment.** This LGIA may be assigned by a Party only with the written consent of the other Parties; provided that a Party may assign this LGIA without the consent of the other Parties to any Affiliate of the assigning Party with an equal or greater credit rating and with the legal authority and operational ability to satisfy the obligations of the assigning Party under this LGIA; and provided further that the Interconnection Customer shall have the right to assign this LGIA, without the consent of the CAISO or Participating TO, for collateral security purposes to aid in providing financing for the Large Generating Facility, provided that the Interconnection Customer will promptly notify the CAISO and

Participating TO of any such assignment. Any financing arrangement entered into by the Interconnection Customer pursuant to this Article will provide that prior to or upon the exercise of the secured party's, trustee's or mortgagee's assignment rights pursuant to said arrangement, the secured creditor, the trustee or mortgagee will notify the CAISO and Participating TO of the date and particulars of any such exercise of assignment right(s), including providing the CAISO and Participating TO with proof that it meets the requirements of Articles 11.5 and 18.3. Any attempted assignment that violates this Article is void and ineffective. Any assignment under this LGIA shall not relieve a Party of its obligations, nor shall a Party's obligations be enlarged, in whole or in part, by reason thereof. Where required, consent to assignment will not be unreasonably withheld, conditioned or delayed.

## **ARTICLE 20. SEVERABILITY**

- 20.1 Severability.** If any provision in this LGIA is finally determined to be invalid, void or unenforceable by any court or other Governmental Authority having jurisdiction, such determination shall not invalidate, void or make unenforceable any other provision, agreement or covenant of this LGIA; provided that if the Interconnection Customer (or any third party, but only if such third party is not acting at the direction of the Participating TO or CAISO) seeks and obtains such a final determination with respect to any provision of the Alternate Option (Article 5.1.2), or the Negotiated Option (Article 5.1.4), then none of the provisions of Article 5.1.2 or 5.1.4 shall thereafter have any force or effect and the Parties' rights and obligations shall be governed solely by the Standard Option (Article 5.1.1).

## **ARTICLE 21. COMPARABILITY**

- 21.1 Comparability.** The Parties will comply with all applicable comparability and code of conduct laws, rules and regulations, as amended from time to time.

## **ARTICLE 22. CONFIDENTIALITY**

- 22.1 Confidentiality.** Confidential Information shall include, without limitation, all information relating to a Party's technology, research and development, business affairs, and pricing, and any information supplied by any of the Parties to the other Parties prior to the execution of this LGIA.

Information is Confidential Information only if it is clearly designated or marked in writing as confidential on the face of the document, or, if the information is conveyed orally or by inspection, if the Party providing the information orally informs the Parties receiving the information that the information is confidential.

If requested by any Party, the other Parties shall provide in writing, the basis for asserting that the information referred to in this Article 22 warrants confidential treatment, and the requesting Party may disclose such writing to the appropriate Governmental Authority. Each Party shall be responsible for the costs associated with affording confidential treatment to its information.

22.1.1 Term. During the term of this LGIA, and for a period of three (3) years after the expiration or termination of this LGIA, except as otherwise provided in this Article 22, each Party shall hold in confidence and shall not disclose to any person Confidential Information.

22.1.2 Scope. Confidential Information shall not include information that the receiving Party can demonstrate: (1) is generally available to the public other than as a result of a disclosure by the receiving Party; (2) was in the lawful possession of the receiving Party on a non-confidential basis before receiving it from the disclosing Party; (3) was supplied to the receiving Party without restriction by a third party, who, to the knowledge of the receiving Party after due inquiry, was under no obligation to the disclosing Party to keep such information confidential; (4) was independently developed by the receiving Party without reference to Confidential Information of the disclosing Party; (5) is, or becomes, publicly known, through no wrongful act or omission of the receiving Party or Breach of this LGIA; or (6) is required, in accordance with Article 22.1.7 of this LGIA, Order of Disclosure, to be disclosed by any Governmental Authority or is otherwise required to be disclosed by law or subpoena, or is necessary in any legal proceeding establishing rights and obligations under this LGIA. Information designated as Confidential Information will no longer be deemed confidential if the Party that designated the information as confidential notifies the other Parties that it no longer is confidential.

22.1.3 Release of Confidential Information. No Party shall release or disclose Confidential Information to any other person, except to its employees, consultants, Affiliates (limited by the Standards of Conduct requirements set forth in Part 358 of FERC's Regulations, 18 C.F.R. 358), subcontractors, or to parties who may be or considering providing financing to or equity participation with the Interconnection Customer, or to potential purchasers or assignees of the Interconnection Customer, on a need-to-know basis in connection with this LGIA, unless such person has first been advised of the confidentiality provisions of this Article 22 and has agreed to comply with such provisions. Notwithstanding the foregoing, a Party providing Confidential Information to any person shall remain primarily responsible for any release of Confidential Information in contravention of this Article 22.

- 22.1.4 Rights. Each Party retains all rights, title, and interest in the Confidential Information that each Party discloses to the other Parties. The disclosure by each Party to the other Parties of Confidential Information shall not be deemed a waiver by a Party or any other person or entity of the right to protect the Confidential Information from public disclosure.
- 22.1.5 No Warranties. The mere fact that a Party has provided Confidential Information does not constitute a warranty or representation as to its accuracy or completeness. In addition, by supplying Confidential Information, no Party obligates itself to provide any particular information or Confidential Information to the other Parties nor to enter into any further agreements or proceed with any other relationship or joint venture.
- 22.1.6 Standard of Care. Each Party shall use at least the same standard of care to protect Confidential Information it receives as it uses to protect its own Confidential Information from unauthorized disclosure, publication or dissemination. Each Party may use Confidential Information solely to fulfill its obligations to the other Parties under this LGIA or its regulatory requirements.
- 22.1.7 Order of Disclosure. If a court or a Government Authority or entity with the right, power, and apparent authority to do so requests or requires any Party, by subpoena, oral deposition, interrogatories, requests for production of documents, administrative order, or otherwise, to disclose Confidential Information, that Party shall provide the other Parties with prompt notice of such request(s) or requirement(s) so that the other Parties may seek an appropriate protective order or waive compliance with the terms of this LGIA. Notwithstanding the absence of a protective order or waiver, the Party may disclose such Confidential Information which, in the opinion of its counsel, the Party is legally compelled to disclose. Each Party will use Reasonable Efforts to obtain reliable assurance that confidential treatment will be accorded any Confidential Information so furnished.
- 22.1.8 Termination of Agreement. Upon termination of this LGIA for any reason, each Party shall, within ten (10) Calendar Days of receipt of a written request from another Party, use Reasonable Efforts to destroy, erase, or delete (with such destruction, erasure, and deletion certified in writing to the other Party) or return to the other Party, without retaining copies thereof, any and all written or electronic Confidential Information received from the other Party.
- 22.1.9 Remedies. The Parties agree that monetary damages would be inadequate to compensate a Party for another Party's Breach of its obligations under this Article 22. Each Party accordingly agrees that the other Parties shall be entitled to equitable relief, by way of injunction or

otherwise, if the first Party Breaches or threatens to Breach its obligations under this Article 22, which equitable relief shall be granted without bond or proof of damages, and the receiving Party shall not plead in defense that there would be an adequate remedy at law. Such remedy shall not be deemed an exclusive remedy for the Breach of this Article 22, but shall be in addition to all other remedies available at law or in equity. The Parties further acknowledge and agree that the covenants contained herein are necessary for the protection of legitimate business interests and are reasonable in scope. No Party, however, shall be liable for indirect, incidental, or consequential or punitive damages of any nature or kind resulting from or arising in connection with this Article 22.

22.1.10 Disclosure to FERC, its Staff, or a State. Notwithstanding anything in this Article 22 to the contrary, and pursuant to 18 C.F.R. section 1b.20, if FERC or its staff, during the course of an investigation or otherwise, requests information from one of the Parties that is otherwise required to be maintained in confidence pursuant to this LGIA, the Party shall provide the requested information to FERC or its staff, within the time provided for in the request for information. In providing the information to FERC or its staff, the Party must, consistent with 18 C.F.R. section 388.112, request that the information be treated as confidential and non-public by FERC and its staff and that the information be withheld from public disclosure. Parties are prohibited from notifying the other Parties to this LGIA prior to the release of the Confidential Information to FERC or its staff. The Party shall notify the other Parties to the LGIA when it is notified by FERC or its staff that a request to release Confidential Information has been received by FERC, at which time any of the Parties may respond before such information would be made public, pursuant to 18 C.F.R. section 388.112. Requests from a state regulatory body conducting a confidential investigation shall be treated in a similar manner if consistent with the applicable state rules and regulations.

22.1.11 Subject to the exception in Article 22.1.10, Confidential Information shall not be disclosed by the other Parties to any person not employed or retained by the other Parties, except to the extent disclosure is (i) required by law; (ii) reasonably deemed by the disclosing Party to be required to be disclosed in connection with a dispute between or among the Parties, or the defense of litigation or dispute; (iii) otherwise permitted by consent of the other Parties, such consent not to be unreasonably withheld; or (iv) necessary to fulfill its obligations under this LGIA or as a transmission service provider or a Balancing Authority including disclosing the Confidential Information to an RTO or ISO or to a regional or national reliability organization. The Party asserting confidentiality shall notify the other Parties in writing of the information it claims is confidential. Prior to any disclosures of another Party's Confidential Information under this subparagraph, or if any third party or Governmental Authority makes any



request or demand for any of the information described in this subparagraph, the disclosing Party agrees to promptly notify the other Party in writing and agrees to assert confidentiality and cooperate with the other Party in seeking to protect the Confidential Information from public disclosure by confidentiality agreement, protective order or other reasonable measures.

## **ARTICLE 23. ENVIRONMENTAL RELEASES**

- 23.1** Each Party shall notify the other Parties, first orally and then in writing, of the release of any Hazardous Substances, any asbestos or lead abatement activities, or any type of remediation activities related to the Large Generating Facility or the Interconnection Facilities, each of which may reasonably be expected to affect the other Parties. The notifying Party shall: (i) provide the notice as soon as practicable, provided such Party makes a good faith effort to provide the notice no later than twenty-four hours after such Party becomes aware of the occurrence; and (ii) promptly furnish to the other Parties copies of any publicly available reports filed with any Governmental Authorities addressing such events.

## **ARTICLE 24. INFORMATION REQUIREMENTS**

- 24.1 Information Acquisition.** The Participating TO and the Interconnection Customer shall submit specific information regarding the electrical characteristics of their respective facilities to each other as described below and in accordance with Applicable Reliability Standards.
- 24.2 Information Submission by Participating TO.** The initial information submission by the Participating TO shall occur no later than one hundred eighty (180) Calendar Days prior to Trial Operation and shall include the Participating TO's Transmission System information necessary to allow the Interconnection Customer to select equipment and meet any system protection and stability requirements, unless otherwise agreed to by the Participating TO and the Interconnection Customer. On a monthly basis the Participating TO shall provide the Interconnection Customer and the CAISO a status report on the construction and installation of the Participating TO's Interconnection Facilities and Network Upgrades, including, but not limited to, the following information: (1) progress to date; (2) a description of the activities since the last report; (3) a description of the action items for the next period; and (4) the delivery status of equipment ordered.
- 24.3 Updated Information Submission by Interconnection Customer.** The updated information submission by the Interconnection Customer, including manufacturer information, shall occur no later than one hundred eighty (180) Calendar Days prior to the Trial Operation. The Interconnection Customer shall

submit a completed copy of the Electric Generating Unit data requirements contained in Appendix 1 to the LGIP. It shall also include any additional information provided to the Participating TO and the CAISO for the Interconnection Studies. Information in this submission shall be the most current Electric Generating Unit design or expected performance data. Information submitted for stability models shall be compatible with the Participating TO and CAISO standard models. If there is no compatible model, the Interconnection Customer will work with a consultant mutually agreed to by the Parties to develop and supply a standard model and associated information.

If the Interconnection Customer's data is materially different from what was originally provided to the Participating TO and the CAISO for the Interconnection Studies, then the Participating TO and the CAISO will conduct appropriate studies pursuant to the LGIP to determine the impact on the Participating TO's Transmission System and affected portions of the CAISO Controlled Grid based on the actual data submitted pursuant to this Article 24.3. The Interconnection Customer shall not begin Trial Operation until such studies are completed and all other requirements of this LGIA are satisfied.

**24.4 Information Supplementation.** Prior to the Trial Operation date, the Parties shall supplement their information submissions described above in this Article 24 with any and all "as-built" Electric Generating Unit information or "as-tested" performance information that differs from the initial submissions or, alternatively, written confirmation that no such differences exist. The Interconnection Customer shall conduct tests on the Electric Generating Unit as required by Good Utility Practice such as an open circuit "step voltage" test on the Electric Generating Unit to verify proper operation of the Electric Generating Unit's automatic voltage regulator.

Unless otherwise agreed, the test conditions shall include: (1) Electric Generating Unit at synchronous speed; (2) automatic voltage regulator on and in voltage control mode; and (3) a five percent (5 percent) change in Electric Generating Unit terminal voltage initiated by a change in the voltage regulators reference voltage. The Interconnection Customer shall provide validated test recordings showing the responses of Electric Generating Unit terminal and field voltages. In the event that direct recordings of these voltages is impractical, recordings of other voltages or currents that mirror the response of the Electric Generating Unit's terminal or field voltage are acceptable if information necessary to translate these alternate quantities to actual Electric Generating Unit terminal or field voltages is provided. Electric Generating Unit testing shall be conducted and results provided to the Participating TO and the CAISO for each individual Electric Generating Unit in a station.

Subsequent to the Commercial Operation Date, the Interconnection Customer shall provide the Participating TO and the CAISO any information changes due to equipment replacement, repair, or adjustment. The Participating TO shall

provide the Interconnection Customer any information changes due to equipment replacement, repair or adjustment in the directly connected substation or any adjacent Participating TO-owned substation that may affect the Interconnection Customer's Interconnection Facilities equipment ratings, protection or operating requirements. The Parties shall provide such information pursuant to Article 5.19.

## **ARTICLE 25. INFORMATION ACCESS AND AUDIT RIGHTS**

- 25.1 Information Access.** Each Party (the “disclosing Party”) shall make available to the other Party information that is in the possession of the disclosing Party and is necessary in order for the other Party to: (i) verify the costs incurred by the disclosing Party for which the other Party is responsible under this LGIA; and (ii) carry out its obligations and responsibilities under this LGIA. The Parties shall not use such information for purposes other than those set forth in this Article 25.1 and to enforce their rights under this LGIA. Nothing in this Article 25 shall obligate the CAISO to make available to a Party any third party information in its possession or control if making such third party information available would violate a CAISO Tariff restriction on the use or disclosure of such third party information.
- 25.2 Reporting of Non-Force Majeure Events.** Each Party (the “notifying Party”) shall notify the other Parties when the notifying Party becomes aware of its inability to comply with the provisions of this LGIA for a reason other than a Force Majeure event. The Parties agree to cooperate with each other and provide necessary information regarding such inability to comply, including the date, duration, reason for the inability to comply, and corrective actions taken or planned to be taken with respect to such inability to comply. Notwithstanding the foregoing, notification, cooperation or information provided under this Article shall not entitle the Party receiving such notification to allege a cause for anticipatory breach of this LGIA.
- 25.3 Audit Rights.** Subject to the requirements of confidentiality under Article 22 of this LGIA, the Parties' audit rights shall include audits of a Party's costs pertaining to such Party's performance or satisfaction of obligations owed to the other Party under this LGIA, calculation of invoiced amounts, the CAISO's efforts to allocate responsibility for the provision of reactive support to the CAISO Controlled Grid, the CAISO's efforts to allocate responsibility for interruption or reduction of generation on the CAISO Controlled Grid, and each such Party's actions in an Emergency Condition.
- 25.3.1 The Interconnection Customer and the Participating TO shall each have the right, during normal business hours, and upon prior reasonable notice to the other Party, to audit at its own expense the other Party's accounts and records pertaining to either such Party's performance or either such Party's satisfaction of obligations owed to the other Party under this LGIA.

Subject to Article 25.3.2, any audit authorized by this Article shall be performed at the offices where such accounts and records are maintained and shall be limited to those portions of such accounts and records that relate to each such Party's performance and satisfaction of obligations under this LGIA. Each such Party shall keep such accounts and records for a period equivalent to the audit rights periods described in Article 25.4.

25.3.2 Notwithstanding anything to the contrary in Article 25.3, each Party's rights to audit the CAISO's accounts and records shall be as set forth in Section 22.1 of the CAISO Tariff.

## **25.4 Audit Rights Periods.**

25.4.1 Audit Rights Period for Construction-Related Accounts and Records.

Accounts and records related to the design, engineering, procurement, and construction of Participating TO's Interconnection Facilities, Network Upgrades, and Distribution Upgrades constructed by the Participating TO shall be subject to audit for a period of twenty-four months following the Participating TO's issuance of a final invoice in accordance with Article 12.2. Accounts and records related to the design, engineering, procurement, and construction of Participating TO's Interconnection Facilities and/or Stand Alone Network Upgrades constructed by the Interconnection Customer shall be subject to audit and verification by the Participating TO and the CAISO for a period of twenty-four months following the Interconnection Customer's issuance of a final invoice in accordance with Article 5.2(8).

25.4.2 Audit Rights Period for All Other Accounts and Records. Accounts and records related to a Party's performance or satisfaction of all obligations under this LGIA other than those described in Article 25.4.1 shall be subject to audit as follows: (i) for an audit relating to cost obligations, the applicable audit rights period shall be twenty-four months after the auditing Party's receipt of an invoice giving rise to such cost obligations; and (ii) for an audit relating to all other obligations, the applicable audit rights period shall be twenty-four months after the event for which the audit is sought; provided that each Party's rights to audit the CAISO's accounts and records shall be as set forth in Section 22.1 of the CAISO Tariff.

**25.5 Audit Results.** If an audit by the Interconnection Customer or the Participating TO determines that an overpayment or an underpayment has occurred with respect to the other Party, a notice of such overpayment or underpayment shall be given to the other Party together with those records from the audit which supports such determination. The Party that is owed payment shall render an invoice to the other Party and such invoice shall be paid pursuant to Article 12 hereof.

25.5.1 Notwithstanding anything to the contrary in Article 25.5, the Interconnection Customer's and Participating TO's rights to audit the CAISO's accounts and records shall be as set forth in Section 22.1 of the CAISO Tariff, and the CAISO's process for remedying an overpayment or underpayment shall be as set forth in the CAISO Tariff.

## **ARTICLE 26. SUBCONTRACTORS**

- 26.1 General.** Nothing in this LGIA shall prevent a Party from utilizing the services of any subcontractor as it deems appropriate to perform its obligations under this LGIA; provided, however, that each Party shall require its subcontractors to comply with all applicable terms and conditions of this LGIA in providing such services and each Party shall remain primarily liable to the other Party for the performance of such subcontractor.
- 26.2 Responsibility of Principal.** The creation of any subcontract relationship shall not relieve the hiring Party of any of its obligations under this LGIA. The hiring Party shall be fully responsible to the other Parties for the acts or omissions of any subcontractor the hiring Party hires as if no subcontract had been made; provided, however, that in no event shall the CAISO or Participating TO be liable for the actions or inactions of the Interconnection Customer or its subcontractors with respect to obligations of the Interconnection Customer under Article 5 of this LGIA. Any applicable obligation imposed by this LGIA upon the hiring Party shall be equally binding upon, and shall be construed as having application to, any subcontractor of such Party.
- 26.3 No Limitation by Insurance.** The obligations under this Article 26 will not be limited in any way by any limitation of subcontractor's insurance.

## **ARTICLE 27. DISPUTES**

All disputes arising out of or in connection with this LGIA whereby relief is sought by or from the CAISO shall be settled in accordance with the provisions of Article 13 of the CAISO Tariff, except that references to the CAISO Tariff in such Article 13 of the CAISO Tariff shall be read as references to this LGIA. Disputes arising out of or in connection with this LGIA not subject to provisions of Article 13 of the CAISO Tariff shall be resolved as follows:

- 27.1 Submission.** In the event either Party has a dispute, or asserts a claim, that arises out of or in connection with this LGIA or its performance, such Party (the "disputing Party") shall provide the other Party with written notice of the dispute or claim ("Notice of Dispute"). Such dispute or claim shall be referred to a designated senior representative of each Party for resolution on an informal basis as promptly as practicable after receipt of the Notice of Dispute by the other Party. In the event the designated representatives are unable to resolve the

claim or dispute through unassisted or assisted negotiations within thirty (30) Calendar Days of the other Party's receipt of the Notice of Dispute, such claim or dispute may, upon mutual agreement of the Parties, be submitted to arbitration and resolved in accordance with the arbitration procedures set forth below. In the event the Parties do not agree to submit such claim or dispute to arbitration, each Party may exercise whatever rights and remedies it may have in equity or at law consistent with the terms of this LGIA.

**27.2 External Arbitration Procedures.** Any arbitration initiated under this LGIA shall be conducted before a single neutral arbitrator appointed by the Parties. If the Parties fail to agree upon a single arbitrator within ten (10) Calendar Days of the submission of the dispute to arbitration, each Party shall choose one arbitrator who shall sit on a three-member arbitration panel. The two arbitrators so chosen shall within twenty (20) Calendar Days select a third arbitrator to chair the arbitration panel. In either case, the arbitrators shall be knowledgeable in electric utility matters, including electric transmission and bulk power issues, and shall not have any current or past substantial business or financial relationships with any party to the arbitration (except prior arbitration). The arbitrator(s) shall provide each of the Parties an opportunity to be heard and, except as otherwise provided herein, shall conduct the arbitration in accordance with the Commercial Arbitration Rules of the American Arbitration Association ("Arbitration Rules") and any applicable FERC regulations; provided, however, in the event of a conflict between the Arbitration Rules and the terms of this Article 27, the terms of this Article 27 shall prevail.

**27.3 Arbitration Decisions.** Unless otherwise agreed by the Parties, the arbitrator(s) shall render a decision within ninety (90) Calendar Days of appointment and shall notify the Parties in writing of such decision and the reasons therefor. The arbitrator(s) shall be authorized only to interpret and apply the provisions of this LGIA and shall have no power to modify or change any provision of this Agreement in any manner. The decision of the arbitrator(s) shall be final and binding upon the Parties, and judgment on the award may be entered in any court having jurisdiction. The decision of the arbitrator(s) may be appealed solely on the grounds that the conduct of the arbitrator(s), or the decision itself, violated the standards set forth in the Federal Arbitration Act or the Administrative Dispute Resolution Act. The final decision of the arbitrator(s) must also be filed with FERC if it affects jurisdictional rates, terms and conditions of service, Interconnection Facilities, or Network Upgrades.

**27.4 Costs.** Each Party shall be responsible for its own costs incurred during the arbitration process and for the following costs, if applicable: (1) the cost of the arbitrator chosen by the Party to sit on the three member panel and one half of the cost of the third arbitrator chosen; or (2) one half the cost of the single arbitrator jointly chosen by the Parties.

## **ARTICLE 28. REPRESENTATIONS, WARRANTIES AND COVENANTS**

**28.1 General.** Each Party makes the following representations, warranties and covenants:

- 28.1.1 **Good Standing.** Such Party is duly organized, validly existing and in good standing under the laws of the state in which it is organized, formed, or incorporated, as applicable; that it is qualified to do business in the state or states in which the Large Generating Facility, Interconnection Facilities and Network Upgrades owned by such Party, as applicable, are located; and that it has the corporate power and authority to own its properties, to carry on its business as now being conducted and to enter into this LGIA and carry out the transactions contemplated hereby and perform and carry out all covenants and obligations on its part to be performed under and pursuant to this LGIA.
- 28.1.2 **Authority.** Such Party has the right, power and authority to enter into this LGIA, to become a Party hereto and to perform its obligations hereunder. This LGIA is a legal, valid and binding obligation of such Party, enforceable against such Party in accordance with its terms, except as the enforceability thereof may be limited by applicable bankruptcy, insolvency, reorganization or other similar laws affecting creditors' rights generally and by general equitable principles (regardless of whether enforceability is sought in a proceeding in equity or at law).
- 28.1.3 **No Conflict.** The execution, delivery and performance of this LGIA does not violate or conflict with the organizational or formation documents, or bylaws or operating agreement, of such Party, or any judgment, license, permit, order, material agreement or instrument applicable to or binding upon such Party or any of its assets.
- 28.1.4 **Consent and Approval.** Such Party has sought or obtained, or, in accordance with this LGIA will seek or obtain, each consent, approval, authorization, order, or acceptance by any Governmental Authority in connection with the execution, delivery and performance of this LGIA, and it will provide to any Governmental Authority notice of any actions under this LGIA that are required by Applicable Laws and Regulations.

## **ARTICLE 29. [RESERVED]**

## **ARTICLE 30. MISCELLANEOUS**

- 30.1 Binding Effect.** This LGIA and the rights and obligations hereof, shall be binding upon and shall inure to the benefit of the successors and assigns of the Parties hereto.
- 30.2 Conflicts.** In the event of a conflict between the body of this LGIA and any attachment, appendices or exhibits hereto, the terms and provisions of the body of this LGIA shall prevail and be deemed the final intent of the Parties.
- 30.3 Rules of Interpretation.** This LGIA, unless a clear contrary intention appears, shall be construed and interpreted as follows: (1) the singular number includes the plural number and vice versa; (2) reference to any person includes such person's successors and assigns but, in the case of a Party, only if such successors and assigns are permitted by this LGIA, and reference to a person in a particular capacity excludes such person in any other capacity or individually; (3) reference to any agreement (including this LGIA), document, instrument or tariff means such agreement, document, instrument, or tariff as amended or modified and in effect from time to time in accordance with the terms thereof and, if applicable, the terms hereof; (4) reference to any Applicable Laws and Regulations means such Applicable Laws and Regulations as amended, modified, codified, or reenacted, in whole or in part, and in effect from time to time, including, if applicable, rules and regulations promulgated thereunder; (5) unless expressly stated otherwise, reference to any Article, Section or Appendix means such Article of this LGIA or such Appendix to this LGIA, or such Section to the LGIP or such Appendix to the LGIP, as the case may be; (6) "hereunder", "hereof", "herein", "hereto" and words of similar import shall be deemed references to this LGIA as a whole and not to any particular Article or other provision hereof or thereof; (7) "including" (and with correlative meaning "include") means including without limiting the generality of any description preceding such term; and (8) relative to the determination of any period of time, "from" means "from and including", "to" means "to but excluding" and "through" means "through and including".
- 30.4 Entire Agreement.** This LGIA, including all Appendices and Schedules attached hereto, constitutes the entire agreement among the Parties with reference to the subject matter hereof, and supersedes all prior and contemporaneous understandings or agreements, oral or written, between or among the Parties with respect to the subject matter of this LGIA. There are no other agreements, representations, warranties, or covenants which constitute any part of the consideration for, or any condition to, any Party's compliance with its obligations under this LGIA.
- 30.5 No Third Party Beneficiaries.** This LGIA is not intended to and does not create rights, remedies, or benefits of any character whatsoever in favor of any persons, corporations, associations, or entities other than the Parties, and the obligations herein assumed are solely for the use and benefit of the Parties, their successors in interest and, where permitted, their assigns.



**30.6 Waiver.** The failure of a Party to this LGIA to insist, on any occasion, upon strict performance of any provision of this LGIA will not be considered a waiver of any obligation, right, or duty of, or imposed upon, such Party.

Any waiver at any time by either Party of its rights with respect to this LGIA shall not be deemed a continuing waiver or a waiver with respect to any other failure to comply with any other obligation, right, duty of this LGIA. Termination or Default of this LGIA for any reason by the Interconnection Customer shall not constitute a waiver of the Interconnection Customer's legal rights to obtain an interconnection from the Participating TO. Any waiver of this LGIA shall, if requested, be provided in writing.

**30.7 Headings.** The descriptive headings of the various Articles of this LGIA have been inserted for convenience of reference only and are of no significance in the interpretation or construction of this LGIA.

**30.8 Multiple Counterparts.** This LGIA may be executed in two or more counterparts, each of which is deemed an original but all constitute one and the same instrument.

**30.9 Amendment.** The Parties may by mutual agreement amend this LGIA by a written instrument duly executed by all of the Parties. Such amendment shall become effective and a part of this LGIA upon satisfaction of all Applicable Laws and Regulations.

**30.10 Modification by the Parties.** The Parties may by mutual agreement amend the Appendices to this LGIA by a written instrument duly executed by all of the Parties. Such amendment shall become effective and a part of this LGIA upon satisfaction of all Applicable Laws and Regulations.

**30.11 Reservation of Rights.** The CAISO and Participating TO shall each have the right to make a unilateral filing with FERC to modify this LGIA pursuant to section 205 or any other applicable provision of the Federal Power Act and FERC's rules and regulations thereunder with respect to the following Articles and Appendices of this LGIA and with respect to any rates, terms and conditions, charges, classifications of service, rule or regulation covered by these Articles and Appendices:

Recitals, 1, 2.1, 2.2, 2.3, 2.4, 2.6, 3.1, 3.3, 4.1, 4.2, 4.3, 4.4, 5 preamble, 5.4, 5.7, 5.8, 5.9, 5.12, 5.13, 5.18, 5.19.1, 7.1, 7.2, 8, 9.1, 9.2, 9.3, 9.5, 9.6, 9.7, 9.8, 9.10, 10.3, 11.4, 12.1, 13, 14, 15, 16, 17, 18, 19, 20, 21, 22, 23, 24.3, 24.4, 25.1, 25.2, 25.3 (excluding subparts), 25.4.2, 26, 28, 29, 30, Appendix D, Appendix F, Appendix G, and any other Article not reserved exclusively to the Participating TO or the CAISO below.

The Participating TO shall have the exclusive right to make a unilateral filing with FERC to modify this LGIA pursuant to section 205 or any other applicable provision of the Federal Power Act and FERC's rules and regulations thereunder with respect to the following Articles and Appendices of this LGIA and with respect to any rates, terms and conditions, charges, classifications of service, rule or regulation covered by these Articles and Appendices:

2.5, 5.1, 5.2, 5.3, 5.5, 5.6, 5.10, 5.11, 5.14, 5.15, 5.16, 5.17, 5.19 (excluding 5.19.1), 6, 7.3, 9.4, 9.9, 10.1, 10.2, 10.4, 10.5, 11.1, 11.2, 11.3, 11.5, 12.2, 12.3, 12.4, 24.1, 24.2, 25.3.1, 25.4.1, 25.5 (excluding 25.5.1), 27 (excluding preamble), Appendix A, Appendix B, Appendix C, and Appendix E.

The CAISO shall have the exclusive right to make a unilateral filing with FERC to modify this LGIA pursuant to section 205 or any other applicable provision of the Federal Power Act and FERC's rules and regulations thereunder with respect to the following Articles of this LGIA and with respect to any rates, terms and conditions, charges, classifications of service, rule or regulation covered by these Articles:

3.2, 4.5, 11.6, 25.3.2, 25.5.1, and 27 preamble.

The Interconnection Customer, the CAISO, and the Participating TO shall have the right to make a unilateral filing with FERC to modify this LGIA pursuant to section 206 or any other applicable provision of the Federal Power Act and FERC's rules and regulations thereunder; provided that each Party shall have the right to protest any such filing by another Party and to participate fully in any proceeding before FERC in which such modifications may be considered. Nothing in this LGIA shall limit the rights of the Parties or of FERC under sections 205 or 206 of the Federal Power Act and FERC's rules and regulations thereunder, except to the extent that the Parties otherwise mutually agree as provided herein.

**30.12 No Partnership.** This LGIA shall not be interpreted or construed to create an association, joint venture, agency relationship, or partnership among the Parties or to impose any partnership obligation or partnership liability upon any Party. No Party shall have any right, power or authority to enter into any agreement or undertaking for, or act on behalf of, or to act as or be an agent or representative of, or to otherwise bind, another Party.

**30.13 Joint and Several Obligations.** Except as otherwise provided in this LGIA, the obligations of the CAISO, the Participating TO, and the Interconnection Customer are several, and are neither joint nor joint and several.

**IN WITNESS WHEREOF**, the Parties have executed this LGIA in multiple originals, each of which shall constitute and be an original effective agreement among the Parties.

**NextEra Blythe Solar Energy Center, LLC**

By:  /s/ Gregory Schneck \_\_\_\_\_

Name:  Gregory Schneck \_\_\_\_\_

Title:  Vice President \_\_\_\_\_

Date:  6/3/2016 \_\_\_\_\_

**Southern California Edison Company**

By:  /s/ Robert G. Woods \_\_\_\_\_

Name:  Robert G. Woods \_\_\_\_\_

Title:  Managing Director,  
T&D Asset Management and Operations Support

Date:  6/10/2016 \_\_\_\_\_

**California Independent System Operator Corporation**

By:  /s/ Keith Casey \_\_\_\_\_

Name:  Keith Casey \_\_\_\_\_

Title:  VP Market & Infrastructure Development \_\_\_\_\_

Date:  6/7/2016 \_\_\_\_\_

**Appendices  
To First Amended LGIA**

- Appendix A Interconnection Facilities, Network Upgrades and Distribution Upgrades
- Appendix B Milestones
- Appendix C Interconnection Details
- Appendix D Security Arrangements Details
- Appendix E Commercial Operation Date
- Appendix F Addresses for Delivery of Notices and Billings
- Appendix G Interconnection Customer's Proportional Share of Costs of Network Upgrades for Applicable Project Group
- Appendix H Interconnection Requirements for an Asynchronous Generating Facility Wind Generating Plant
- Appendix I Consent to Assignment

## **Appendix A**

### **To First Amended LGIA**

#### **Interconnection Facilities, Network Upgrades and Distribution Upgrades**

##### **Recitals to Appendix A**

- A. The Participating TO's Interconnection Facilities, Network Upgrades and Distribution Upgrades described herein are based on the Participating TO's preliminary engineering and design and are subject to modification to reflect the actual facilities that will be constructed and installed following the Participating TO's final engineering and design, identification of field conditions, and compliance with applicable environmental and permitting requirements.
- B. The Interconnection Customer proposed, in its Interconnection Request, to construct a solar thermal Generating Facility referred to herein as "Blythe Solar Power Project", with a maximum net output of 1,000 MW, consisting of four Electric Generating Units, each rated at 250MW. The Interconnection Customer initially requested a Commercial Operation Date of May 1, 2013 for the entire Generating Facility in the Interconnection Request. Further, the Interconnection Customer requested a full capacity deliverability status interconnection. The Interconnection Request was processed along with several other interconnection requests, as part of the CAISO's "Eastern Bulk System Transition Cluster" ("Cluster").
- C. The Phase II Interconnection Study applicable to the Cluster determined that the Participating TO could not construct the Participating TO's Delivery Network Upgrades to meet the full deliverability requests of the Cluster until 2017. In response to this information, the CAISO, the Participating TO, and the Interconnection Customer agreed that the Interconnection Customer could construct the four Electric Generating Units in two sequences, with the First Sequence, consisting of Electric Generating Units 1 & 2 ("First Sequence") and the Second Sequence, consisting of Electric Generating Units 3 & 4 ("Second Sequence"). The Interconnection Customer intends that the sequencing of the construction of the Phased Generating Facility will take place in a manner that matches the construction of the anticipated transmission upgrades and the corresponding availability of transmission necessary for each sequence and therefore has proposed to include within this LGIA provisions for Partial Termination as described in Article 2.4.4 of this LGIA.
- D. On July 12, 2012, as a result of the sale of the Blythe Solar Power Project from Palo Verde Solar II, LLC to NextEra Blythe Solar Energy Center, LLC, the Participating TO, CAISO, Palo Verde Solar II, LLC, and NextEra Blythe Solar Energy Center, LLC entered into the Consent To Assignment For Large

Generator Interconnection Agreement (“Consent”) pursuant to which the LGIA was assigned from Palo Verde Solar II, LLC to NextEra Blythe Solar Energy Center, LLC. As a result of project milestones previously missed by Palo Verde Solar II, LLC and as stipulated in the Consent, following the Blythe Solar Power Project asset sale closing date, the LGIA would be amended to i) allocate the financing obligation to NextEra Blythe Solar Energy Center, LLC for the Participating TO’s Plan of Service Reliability Network Upgrades, and ii) develop new prospective project milestones for NextEra Blythe Solar Energy Center, LLC subject to acceptance by the Participating TO and CAISO. In accordance with the Consent, the Consent is incorporated herein and is attached hereto as Appendix I.

- E. On October 29, 2012, in accordance with Article 5.1.1 of the LGIA, the Participating TO provided written notification to the Interconnection Customer that, for various reasons, Participating TO reasonably expects that the upgrades comprising the Participating TO’s Delivery Network Upgrades would be delayed by at least a year or longer than the estimated completion date shown in the LGIA. Participating TO further informed the Interconnection Customer that it would undertake Reasonable Efforts to meet the next feasible date for completion of Participating TO’s Delivery Network Upgrades and would provide additional notice to the Interconnection Customer as the estimate for Participating TO’s Delivery Network Upgrades becomes clearer. Participating TO now estimates that the next feasible date for completion of the Participating TO’s Delivery Network Upgrades is August 1, 2021, which date is subject to change based on the outcome of the Participating TO’s ongoing Certificate of Public Convenience and Necessity (CPCN) proceeding at the CPUC.
- F. On December 20, 2012, in response to Interconnection Customer’s October 19, 2012 request to modify the 1000 MW Generating Facility technology from solar thermal to solar photovoltaic, the CAISO informed Interconnection Customer that the modification review performed by the Participating TO and the CAISO identified that only 485 MW of the 1000 MW Generating Facility could be converted to solar photovoltaic technology without causing a material impact to later queued generation projects. On December 31, 2012, Interconnection Customer provided written notification to the CAISO confirming its decision to convert 485 MW of the 1000 MW Generating Facility to solar photovoltaic technology.
- G. On January 4, 2013, Interconnection Customer submitted its request to reduce the Generating Facility capacity from 1000 MW to 485 MW in accordance with the CAISO Tariff Appendix GG, One-Time Interconnecting Generator Downsizing Opportunity. The Participating TO and CAISO performed the associated downsizing study, the results of which were provided to the Interconnection Customer in the Blythe Solar Power Project Generator Downsizing Study Report dated July 8, 2013. The study results primarily identified that the Generating Facility at its reduced 485 MW capacity would require a single gentie-line position

at Colorado River Substation (in lieu of the two gentie-line positions originally identified to accommodate the 1000 MW Generating Facility) and that the LGIA would be amended accordingly.

- H. On May 22, 2013, in accordance with the “Procedures to Exercise Option Rights for Interim West of Devers Project” dated April 2, 2013, as such procedures were developed by the Participating TO and the CAISO, Interconnection Customer provided written notification to the Participating TO and the CAISO of its election for the Blythe Solar Power Project to participate in the Interim West of Devers Project. The Interconnection Customer’s option to participate in the Interim West of Devers Project is described in CAISO’s letter to FERC dated December 23, 2011 under the subject “Interim West of Devers Project Beneficiaries” as filed in FERC Docket Number ER12-804. The Interim West of Devers Project enables the Blythe Solar Power Project, and certain other generating facilities, including the generating facility having CAISO Queue No. 193, to attain Full Capacity Deliverability Status for an interim period until the Participating TO’s Delivery Network Upgrades can be constructed and placed in service.
- I. On January 15, 2014 and August 12, 2014, respectively, Interconnection Customer received California Energy Commission (“CEC”) and Bureau of Land Management (“BLM”) approval to use solar photovoltaic technology for the amended 485 MW Blythe Solar Power Project; and on March 19, 2015, Interconnection Customer received CEC and BLM approval to commence construction activities.
- J. Prior to the events described above, the First Sequence of the Phased Generating Facility was originally scheduled to achieve Commercial Operation beginning November 1, 2013 (Electric Generating Unit 1 by November 1, 2013 and Electric Generating Unit 2 by April 1, 2014) and the Second Sequence (Electric Generating Units 3 & 4) was originally scheduled to achieve Commercial Operation in 2017. The Interconnection Customer now expects the First Sequence (Unit 1 at 110 MW and Unit 2 at 125 MW after downsize) to achieve Commercial Operation in 2016, and the Second Sequence (Unit 3 at 125 MW and Unit 4 at 125 MW after downsize) to achieve Commercial Operation in 2020.
- K. On November 19, 2015, Interconnection Customer provided written notification to the Participating TO and CAISO that the Generating Facility name is changed from the Blythe Solar Power Project to the Dracker Project, for uniformity with the name designated to the generation tie-line in Appendix A, Section 1.a.i. of this First Amended LGIA.
- L. Therefore, this First Amended LGIA is being entered into to: (1) allocate the financing obligation for the Participating TO’s Plan of Service Reliability Network Upgrades to the Interconnection Customer; (2) grant the Participating TO the right to allocate \$2,600,000 collected in cash payment for the Participating TO’s Interconnection Facilities to the payment obligation of the Interconnection

Customer for the Participating TO's Plan of Service Reliability Network Upgrades; (3) provide that Interconnection Customer will receive a refund equal to the amount of Credit Support held by the Participating TO that is no longer required; (4) update milestones in Appendix A and Appendix B, to reflect updated estimated completion dates for Participating TO's Delivery Network Upgrades and Interconnection Customer's Phased Generating Facility consistent with current expectations; (5) modify the Generating Facility name, technology, capacity, and associated details; (6) provide for the Generating Facility to participate in the Interim West of Devers Project and attain Full Capacity Deliverability Status for an interim period until the Participating TO's Delivery Network Upgrades can be constructed and placed in service; and (7) make other miscellaneous updates to the original LGIA where appropriate.

## **Operative Provisions of Appendix A**

### **1. Interconnection Facilities:**

- a. **Interconnection Customer's Interconnection Facilities.** The Interconnection Customer shall -
  - i. Construct a new or utilize existing, approximately 10 mile, 220kV double circuit tower line with one generation tie-line circuit comprised of 2B-1272 kcmil Bittern conductor for the Dracker Project to a position designated by the Participating TO, outside of the Participating TO's Colorado River Substation, where Interconnection Customer shall install a structure designed and engineered in accordance with the Participating TO's specifications ("Last Structure"). This generation tie-line circuit will be called the Colorado River-Dracker 220kV Transmission Line. The right-of-way for the Colorado River-Dracker 220kV Transmission Line shall extend up to the edge of the Colorado River Substation property line.
  - ii. Install optical ground wire ("OPGW") on the Colorado River-Dracker 220kV Transmission Line to provide one of the two telecommunication paths required for the line protection scheme, the Remote Terminal Unit ("RTU"), and the Special Protection System ("SPS"). A significant portion of the existing OPGW previously installed for the generating facility having CAISO Queue #193 (McCoy Station) will be shared with the Dracker Project to meet these requirements. McCoy Station and the Dracker Project shall each provide a minimum of eight (8) strands within the OPGW for the Participating TO's exclusive use into Colorado River Substation.
  - iii. Provide required data signals and make available adequate space, facilities, and associated dedicated electrical circuits within a secure building having suitable environmental controls for the installation of the Participating TO's RTU and telecommunications terminal equipment in accordance with the Interconnection Handbook.
  - iv. Install an appropriate single-mode fiber optic cable from a point outside Colorado River Substation (as designated by the Participating TO) to the Generating Facility to provide the second diverse telecommunications path



required for the line protection scheme and the SPS. A significant portion of the existing single-mode fiber optic cable previously installed for the generating facility having CAISO Queue #193 (McCoy Station) will be shared with the Dracker Project to meet these requirements. McCoy Station and the Dracker Project shall each provide a minimum of eight (8) strands within the single-mode fiber optic cable for the Participating TO's exclusive use. The telecommunications path shall meet the Applicable Reliability Standards criteria for diversity.

- v. Own, operate and maintain both telecommunications paths (including OPGW, any fiber-optic cables, and appurtenant facilities), with the exception of the terminal equipment at both Colorado River Substation and at the Generating Facility, which terminal equipment will be installed, owned, operated and maintained by the Participating TO.
- vi. Extend the OPGW and single-mode fiber optic cable for the two telecommunications paths to an Interconnection Customer provided and installed patch panel located adjacent to the Participating TO's telecommunications terminal equipment specified above.
- vii. Allow Participating TO to review Interconnection Customer's telecommunications equipment design and perform inspections to ensure compatibility with Participating TO's terminal equipment and protection engineering requirements.
- viii. Allow Participating TO to perform acceptance testing of Interconnection Customer's telecommunications equipment and give the Participating TO the right to request and/or to perform correction of installation deficiencies as determined by the Participating TO.
- ix. Install, sequentially as needed, all required CAISO approved compliant metering equipment at the Generating Facility, in accordance with Section 10 of the CAISO Tariff.
- x. Grant Participating TO an easement that will provide unrestricted access to Participating TO's Interconnection Facilities located on the Interconnection Customer's side of the Point of Change of Ownership for construction, operation, and maintenance.
- xi. Install a revenue metering cabinet(s) and all required revenue metering equipment (typically, voltage and current transformers) at the Generating Facility to meter the Generating Facility's retail load, as specified by SCE. The metering cabinet(s) must be placed at a location that would allow twenty-four hour access for the Participating TO metering personnel.
- xii. Allow the Participating TO to install, in the revenue metering cabinet(s) provided by the Interconnection Customer, revenue meters and appurtenant equipment required to meter the Generating Facility's retail load.
- xiii. Install the following Colorado River Dracker 220kV Transmission Line protection at the Generating Facility as specified by SCE and provided by the Interconnection Customer:
  - (a) Two (2) current differential relays via diversely routed dedicated digital communication channels to Colorado River Substation. The make and type of current differential relays will be specified by the Participating TO

during final engineering of the Participating TO's Interconnection Facilities.

- xiv. Install necessary relays and satellite synchronized clock to support the SPS requirements for the Generating Facility:
  - (a) Two(2) N60 relays (one each for SPS A and B) to trip the Generating Facility under the Devers RAS (the actual number of relays may increase depending on the actual Generating Facility configuration and final SPS design); and
  - (b) Two(2) N60 relays (one each for SPS A and B) to trip the Generating Facility under the Colorado River Corridor SPS (the actual number of relays may increase depending on the actual Generating Facility configuration and final SPS design)
- xv. Install disconnect facilities in accordance with the Participating TO's Interconnection Handbook to comply with the Participating TO's switching and tagging procedures.

**b. Participating TO's Interconnection Facilities.** The Participating TO shall -

- i. Colorado River-Dracker 220kV Transmission Tie-Line: Install an appropriate number of 220kV transmission tower structures including insulator/hardware assemblies, and appropriate number of spans of conductor and OPGW between the Interconnection Customer-owned Last Structure and the substation dead-end structure at the Colorado River 220kV switchyard. The actual number and location of the transmission tower structures and spans of conductor and OPGW will be determined by the Participating TO following completion of final engineering of the Participating TO's Interconnection Facilities. The Phase II Interconnection Study assumed one (1) transmission tower structure and two (2) spans of conductor and OPGW.
- ii. Colorado River Substation: Install the following facilities to terminate the new Colorado River-Dracker 220kV Transmission Tie-Line:
  - (a) One (1) dead-end substation structure
  - (b) Three (3) 220kV coupling capacitor voltage transformers with steel pedestal support structures
  - (c) Three (3) 220kV line drops
  - (d) Two (2) current differential relays via diversely routed dedicated digital communications channels to the Generating Facility to protect the Colorado River-Dracker 220kV Transmission Line.
  - (e) Two (2) N60 relays at Colorado River Substation (one each for SPS A and SPS B) to send trip signals to the Generating Facility under the Devers RAS
- iii. Metering Services: Install revenue meters and appurtenant equipment at the Generating Facility required to meter the retail load at the Generating Facility. Notwithstanding that the metering will be located on the Interconnection Customer's side of the Point of Change of Ownership, Participating TO shall

own, operate and maintain the metering as part of the Participating TO's Interconnection Facilities

- iv. Power System Control: Install one (1) RTU at the Generating Facility to monitor the typical generation elements such as MW, MVAR, terminal voltage and circuit breaker status at each Electric Generating Unit as well as the plant auxiliary load. This information will be transmitted to the Participating TO's grid control center. Notwithstanding that the RTU will be located on Interconnection Customer's side of the Point of Change of Ownership, Participating TO shall own, operate and maintain the RTU as part of the Participating TO's Interconnection Facilities.
- v. Telecommunications:
  - (a) Install all required light-wave, channel and associated equipment (including terminal equipment) at the Generating Facility and Colorado River Substation to support the protection, RTU, and SCADA requirements for interconnection of the Generating Facility. Notwithstanding that certain telecommunications terminal equipment will be located on the Interconnection Customer's side of the Point of Change of Ownership, Participating TO shall own, operate and maintain such telecommunications terminal equipment as part of the Participating TO's Interconnection Facilities.
  - (b) Install all additional required light-wave, channel, fiber optic cable and associated equipment (including terminal equipment), supporting the SPS requirements. Notwithstanding that certain telecommunications equipment, including the telecommunications terminal equipment, will be located on the Interconnection Customer's side of the Point of Change of Ownership, Participating TO shall own, operate and maintain such telecommunications terminal equipment as part of the Participating TO's Interconnection Facilities.
  - (c) Install underground vaults, risers, conduits, and fiber optic cable as required at the Colorado River Substation to extend both telecommunications paths from the point designated by the Participating TO into the communications room at Colorado River Substation.
- vi. Real Properties, Transmission Project Licensing, and Environmental Health and Safety: Perform all required functions to obtain land easements and/or land acquisition, obtain licensing and permits, and perform required environmental activities for the installation of the Participating TO's Interconnection Facilities, including any associated telecommunications equipment for the Colorado River-Dracker 220kV Transmission Line.

## **2. Network Upgrades:**

- a. **Stand Alone Network Upgrades:** None.

**b. Other Network Upgrades:**

**i. Participating TO's Reliability Network Upgrades:** The Participating TO shall:

Participating TO's Plan of Service Reliability Network Upgrades:

1. Terminate the Colorado River-Dracker 220kV Transmission Line at Colorado River Substation.
  - a. Colorado River Substation
    - i. Install the following equipment for a dedicated 220kV double breaker line position on a breaker-and-a-half configuration to terminate the Colorado River-Dracker 220kV Transmission Tie-Line:
      - (a) Two (2) 220kV 4000A circuit breakers
      - (b) Four (4) 220kV 4000A horizontal-mounted group-operated disconnect switches
      - (c) One (1) grounding switch attachment
      - (d) Eighteen (18) 220kV bus supports with associated steel pedestals
      - (e) 2B-1590 kcmil ACSR conductors
      - (f) Two (2) GE C60 breaker management relays inside existing control room
    - ii. Power System Control – Expand the RTU at Colorado River Substation to install additional points required for the Colorado River-Dracker 220kV Transmission Line.

Other Participating TO's Reliability Network Upgrades:

2. Loop the Colorado River-Devers No.2 500kV Transmission Line into Red Bluff Substation forming the new Devers-Red Bluff No.2 and Colorado-Red Bluff No.2 500kV Transmission Lines. The work requires the following:
  - a. Transmission
    - i. Install approximately one (1) circuit mile of 2B-2156 kcmil ACSR conductor and OPGW
    - ii. Install four (4) dead-end 500kV lattice steel structures
    - iii. Install thirty (30) insulator/hardware assemblies
  - b. Red Bluff 500/220kV Substation
    - i. Install two (2) new double breaker line positions within the 500kV Switchyard to terminate the new Colorado River No. 2 and Devers No. 2 500kV transmission lines
    - ii. Install the following protection relays in the control room
      - (a) Four (4) GE C60 breaker management relays
      - (b) Two (2) GE D60 distance relays (digital communication channel)

- (c) Two (2) GE L90 current differential relay (digital communication channel)
  - (d) Two (2) SEL-421 current differential relay with RFL 9780 on PLCC
  - (e) Two (2) additional RFL 9780 direct transfer trip on Programmable Logic Controller Circuits (“PLCC”)
  - (f) Two (2) RFL 9745 direct transfer trip on PLCC
3. Expand the Colorado River Substation, previously configured as only a 500kV switchyard, to 500/220kV substation by installing one 1120MVA 500/220kV transformer bank with corresponding 500kV and 220kV bank positions and installing a new 220kV switchyard.
- a. Colorado River 1 AA 500/220kV transformer bank 500kV Position - Install the following equipment for a double breaker bank position on a breaker-and-a-half configuration
    - i. One (1) 108 feet high by 90 feet wide dead-end structure
    - ii. Two (2) 500kV-4000A circuit breakers
    - iii. Four (4) 500kV horizontal-mounted group-operated disconnect switches, one of them equipped with grounding attachments
    - iv. Fifteen (15) 500kV bus supports
    - v. 2B-1590 kcmil ACSR conductor
  - b. Colorado River 1 AA 500/220 kV Transformer Bank - Install one 1120MVA 500/220kV Transformer Bank as follows:
    - i. Four (4) 373MVA 500/220kV single-phase units, including one spare unit
    - ii. Three (3) 500kV surge arresters
    - iii. Three (3) 220kV surge arresters
    - iv. One (1) standard seven-position transformer structure with all the required 500kV and 220kV bus-work to allow for the grounded wye/delta connection of the single-phase units and placement of the spare unit
    - v. One (1) 13.8kV tertiary bus equipped as follows:
      - (a) Five (5) 13.8kV-2000A circuit breakers
      - (b) Fifteen (15) 13.8kV hook-stick disconnect switches
      - (c) Five (5) 13.8kV 45MVAR reactors
      - (d) One (1) ground bank detector (3-5MVA 14400-120/240v transformers)
      - (e) One (1) 14400-120V voltmeter potential transformer
      - (f) One (1) voltmeter
      - (g) Three (3) 40E standard size 4 S&C type fuses
    - vi. Approximately 700 circuit feet of 2B-1590 kcmil ACSR conductor for the 500kV and 220kV transformer leads

- c. Colorado River 220kV Switchyard
  - i. Operating buses - Install the following equipment required for a new 220kV switchyard:
    - (a) Six (6) 60 feet high x 90 feet wide bus dead-end structures
    - (b) Twenty-four (24) bus dead-end insulator assemblies
    - (c) Six (6) 220kV potential devices
    - (d) Approximately 920 circuit feet of 2B-1590 kcmil ACSR conductor for the bus
  - ii. Colorado River 1 AA 500/220kV transformer bank 220kV Position - Install the following equipment for a double breaker bank position on a breaker-and-a-half configuration:
    - (a) One (1) 80 feet high by 50 feet wide dead-end structure
    - (b) Two (2) 220kV 4000A circuit breakers
    - (c) Four (4) 220kV 4000A horizontal-mounted group-operated disconnect switches
    - (d) One (1) grounding switch attachment
    - (e) Eighteen (18) 220kV bus supports with associated steel pedestals
    - (f) 2B-1590 kcmil ACSR conductor
- d. Control Room – Install the following protection relays for the No. 1AA 500/220kV transformer banks:
  - (a) Four (4) GE C60 breaker management relays
  - (b) One (1) GE T60 bank differential relay
  - (c) One (1) SEL-387 bank differential relay
  - (d) Four (4) GE C30 sudden pressure aux relay
  - (e) Five (5) GE F60 reactor bank relays (one per reactor)
  - (f) Two (2) SEL-351 ground detector bank relay
  - (g) Twelve (12) GE SBD11B 220kV bus differential relays
- 4. Upgrade the Mira Loma-Vista No.2 220kV Transmission Line drops at Vista Substation. At Vista Substation, replace the existing 2B-1033 kcmil ACSR conductor on the Mira Loma No.2 220kV line position at Vista Substation with new 2B-1590 kcmil ACSR conductor.
- 5. New SPS to trip generation under single/double contingency of the Devers-Red Bluff No.1 and/or Devers-Red Bluff No.2, Colorado River-Red Bluff No. 1 and/or Colorado River-Red Bluff No. 2, and Devers-Valley No. 1 and/or Devers-Valley No. 2 500kV Transmission Lines, and to trip generation connected to Colorado River Substation under either No.1 AA or No.2 AA transformer bank single contingency (“Colorado River Corridor SPS”).
  - a. Devers Substation
    - i. SPS Relays
      - (a) Install required number of N60 relays (for both SPS A and SPS B) for line monitoring and logic processing
      - (b) Install one (1) SEL-2407 satellite synchronized clock

- ii. Telecommunications – install two (2) channel banks (one each for SPS A and SPS B) to support the SPS
- iii. Power Systems Control – replace the RTU at Devers to install additional points required to support the SPS
- b. Red Bluff Substation
  - i. SPS Relays
    - (a) Install required number of N60 relays (for both SPS A and SPS B) for line monitoring and logic processing
    - (b) Install one (1) SEL-2407 satellite synchronized clock
  - ii. Power Systems Control- install dual RTUs for SPS arming, control, status and alarm indication at Red Bluff Substation
- c. Colorado River Substation
  - i. SPS Relays
    - (a) Install required number of N60 relays (for both SPS A and SPS B) for line monitoring, logic processing, and sending of trip signals to the Generating Facility
    - (b) Install one (1) SEL-2407 satellite synchronized clock
  - ii. Power Systems Control – expand the RTU at Colorado River Substation to install additional points required to support the SPS.
- d. Valley Substation
  - i. SPS Relays
    - (a) Install required number of N60 relays (for both SPS A and SPS B) for line monitoring and logic processing
    - (b) Install one (1) SEL-2407 satellite synchronized clock
  - ii. Power Systems Control – expand the RTU at Valley Substation to install additional points required to support the SPS.

The Participating TO's Reliability Network Upgrades described above in Appendix A, Section 2.b.i.4 were triggered by the Transition Cluster, including the Dracker Project. As a result of deferred in-service dates for other generation projects in the Colorado River corridor, operational studies performed by the Participating TO have identified that the Participating TO's Reliability Network Upgrades described in Appendix A, Section 2.b.i.4 can be postponed and are not required to accommodate the Trial Operation or Commercial Operation for the Generating Facility. The installation and completion of these upgrades is contingent upon, and will align with, the future development of such other generation.

- ii. **Participating TO's Delivery Network Upgrades:** The Participating TO shall implement the following Delivery Network Upgrades:
  - 1. West of Devers Upgrades – Upgrade the following existing 220kV transmission lines by rebuilding the lines with new 2B-1590 kcmil ACSR conductors per phase supported on two sets of double-circuit tower structures and replacing all substations' terminal equipment with 4,000A rated elements. Components of this upgrade consist of -

- a. Devers – El Casco 220kV Transmission Line – 30 circuit miles
- b. El Casco – San Bernardino 220kV Transmission Line -14 circuit miles
- c. Devers – San Bernardino 220kV Transmission Line – 43 circuit miles
- d. Devers – Vista No.1 220kV Transmission Line – 45 circuit miles
- e. Devers – Vista No.2 220kV Transmission Line – 45 circuit miles
- f. Devers Substation: Upgrade four 220kV line positions
- g. San Bernardino G.S.: Upgrade two 220kV line positions
- h. Vista Substation: Upgrade two 220kV line positions

The Interim WOD Project, and Interconnection Customer's election to participate therein, will temporarily substitute for the West of Devers Upgrades described in this Appendix A, Section 2.b.ii.1 until the West of Devers Upgrades are completed and placed in service.

- 2. Colorado River Substation Expansion – Installation of the No. 2 AA 1120MVA 500/220kV transformer bank with corresponding 500kV and 220kV bank positions. The components of this upgrade are as follows -
  - a. Colorado River 2 AA 500/220kV transformer bank 500kV Position - Install the following equipment on a two-breaker line position to expand to a three-breaker line / bank position as required to connect the No. 2 AA transformer bank
    - i. one (1) 108 ft. high x 90 ft. wide dead-end structure
    - ii. one (1) 500kV 4000A circuit breaker
    - iii. two (2) 500kV 4000A horizontal-mounted group-operated disconnect switches
    - iv. one (1) grounding switch attachment
    - v. remove twelve (12) 500kV bus supports and corresponding steel pedestals and foundations
  - b. Colorado River 2AA 500/220 kV Transformer Bank – Install one 1120MVA 500/161-220kV Transformer Bank as follows:
    - i. three (3) 373MVA 500/161-220kV single-phase units
    - ii. three (3) 500kV surge arresters
    - iii. three (2) 220kV surge arresters
    - iv. one (1) 13.8kV tertiary bus equipped as follows:
      - (a) five (5) 13.8kV-2000A circuit breakers
      - (b) fifteen (15) 13.8kV hook-stick disconnect switches
      - (c) five (5) 13.8kV 45MVAR reactors
      - (d) one (1) ground bank detector (3-5MVA 14400-120/240v transformers)
      - (e) one (1) 14400-120V voltmeter potential transformer
      - (f) one (1) voltmeter
      - (g) three (3) 40E standard size 4 S&C type fuses



- v. approximately 700 circuit ft. of 2B-1590 kcmil ACSR conductor for the 500kV and 220kV transformer leads
- c. Colorado River 220kV Switchyard – Install the following equipment for a double breaker bank position on a breaker-and-a-half configuration to connect the No. 2 AA 500/220kV transformer bank:
  - i. Colorado River 2 AA 500/220 kV transformer bank 220 kV Position- Install the following equipment on a two-breaker line position to expand to a three-breaker line / bank position as required to connect the No. 2 AA transformer bank
    - (a) one (1) 80 ft. high by 50 ft. wide dead-end structure
    - (b) two (2) 220kV 4000A circuit breakers
    - (c) four (4) 220kV 4000A horizontal-mounted group-operated disconnect switches
    - (d) one (1) grounding switch attachment
    - (e) eighteen 220kV bus supports with associated steel pedestals
    - (f) 2B-1590 kcmil ACSR conductor
  - ii. Control Room – Install the following protection relays for the No. 2 AA 500/220kV transformer banks:
    - (a) four (4) GE C60 breaker management relays
    - (b) one (1) GE T60 bank differential relay
    - (c) one (1) SEL-387 bank differential relay
    - (d) three (3) GE C30 sudden pressure aux relay
    - (e) five (5) GE F60 reactor bank relays (one per reactor)
    - (f) two (2) SEL-351 ground detector bank relay
    - (g) twelve (12) GE SBD11B 220kV bus differential relays

The timing for installation and completion of the Participating TO's Deliverability Network Upgrades described above in this Section 2.b.ii.2 is contingent upon the future development of generation projects in the Colorado River corridor (projects having a position in the CAISO interconnection queue). Such upgrades are not required to accommodate the Trial Operation or Commercial Operation of the Generating Facility and will not impact the Generating Facility's Full Capacity Deliverability Status.

- d. Real Properties, Transmission Project Licensing, and Environmental Health and Safety: Perform all required functions to obtain land easements or land acquisition, obtain licensing and permits, and perform required environmental activities for the installation of the Participating TO's Delivery Network Upgrades.

**3. Distribution Upgrades: None**

**4. Not Used**

**5. Point of Change of Ownership:**

- a. Colorado River-Dracker 220kV Transmission Line: The Point of Change of Ownership shall be the point where the conductors are attached to the Last Structure located directly outside the Colorado River Substation property line. This will be on the side of the Last Structure facing the substation. The Interconnection Customer shall own and maintain the Last Structure, the conductors, insulators and jumper loops from such Last Structure to the Interconnection Customer's Generating Facility. The Participating TO shall own and maintain the Colorado River Substation, as well as all circuit breakers, disconnects, relay facilities and metering within the Colorado River Substation, together with the line drop, in their entirety, from the Last Structure to Colorado River Substation. The Participating TO will own the insulators that are used to attach the Participating TO-owned conductors to the Last Structure.
- b. Telecommunication OPGW: The Point of Change of Ownership shall be at a Participating TO-owned vault outside of the Colorado River Substation perimeter fence where the Interconnection Customer's OPGW for the Colorado River-Dracker 220kV Transmission Line is connected to the Participating TO's fiber optic cable. The Participating TO shall own and maintain all fiber optic cable from that point into the Colorado River Substation.
- c. Telecommunication diverse fiber-optic cable: The Point of Change of Ownership shall be at a Participating TO-owned vault outside of the Colorado River Substation perimeter fence where the Interconnection Customer's diverse fiber optic cable is connected to the Participating TO's fiber optic cable. The Participating TO shall own and maintain all fiber optic cable from that point into the Colorado River Substation.

- 6. Point of Interconnection:** The Participating TO's Colorado River Substation at the 220kV bus.

## 7. One-Line Diagram of Interconnection to Colorado River Substation:

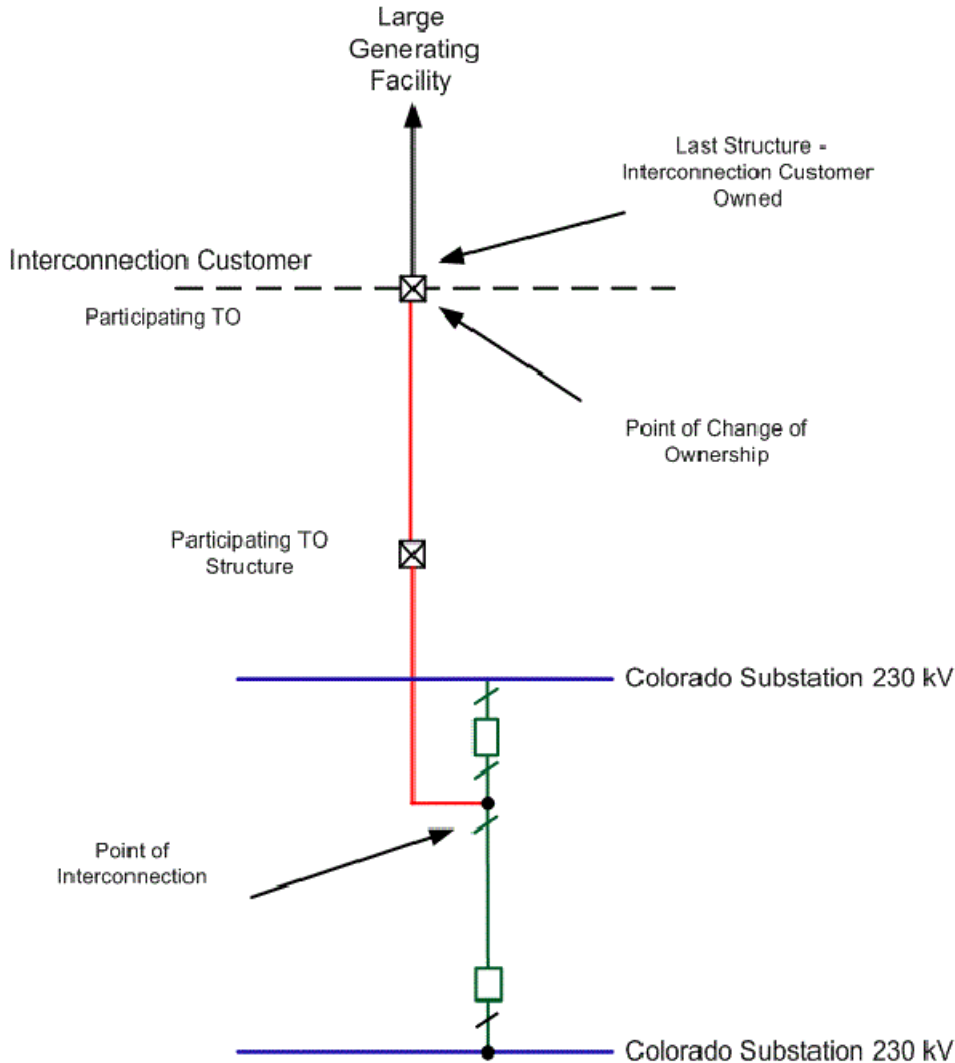

**8. Additional Definitions:** For the purposes of these Appendices, the following terms, when used with initial capitalization, whether in the singular or the plural, shall have the meanings specified below:

- a. Accounting Practice: Generally Accepted Accounting Principles in the United States consistently applied to electric utility operations.
- b. Capital Additions: Any modifications to the Participating TO's Interconnection Facilities in accordance with Article 5.19 of the LGIA. Such modifications may be any Units of Property which are added to the Participating TO's Interconnection Facilities; the enlargement, modification or betterment of any Units of Property constituting a part of the Participating TO's Interconnection Facilities; or the replacement of any Units of Property constituting a part of the Participating TO's

Interconnection Facilities, irrespective of whether such replacement constitutes an enlargement, modification or betterment of that which it replaces; the costs of which additions, enlargements, modifications, betterments or replacements in accordance with Accounting Practice would be capitalized and have not previously been included in the Interconnection Facilities Cost. If Capital Additions are required in order to benefit the Participating TO, or because of damage caused by negligence or willful misconduct of the Participating TO, then the Interconnection Customer will not bear cost responsibility for such Capital Additions, and no adjustment will be made to the Interconnection Facilities Cost, and no Capital Additions Cost or One-Time Cost will be charged to the Interconnection Customer for such Capital Additions.

- c. Cluster: Shall have the meaning ascribed in Appendix A – Recitals to Appendix A.
- d. Colorado River Substation: Participating TO's 500/220kV substation near Blythe, California which is the eastern terminus of Participating TO's Colorado River-Red Bluff No. 2 500kV line.
- e. Construction Activities: Actions by a Participating TO that result in irrevocable financial commitments for the purchase of major electrical equipment or land for Participating TO's Interconnection Facilities or Network Upgrades assigned to the Interconnection Customer that occur after receipt of all appropriate governmental approvals needed for the Participating TO's Interconnection Facilities or Network Upgrades.
- f. CPUC: The California Public Utilities Commission, or its regulatory successor.
- g. Credit Support: Parent guarantee, letter of credit, surety bond, or other security meeting the requirements of Article 11.5 of the LGIA.
- h. Customer-Financed Monthly Rate for Non-ISO-Controlled Facilities: The rate most recently adopted by the CPUC for application to the Participating TO's retail electric customers for customer-financed added facilities, which does not compensate the Participating TO for replacement of added facilities. The currently effective Customer-Financed Monthly Rate for Non-ISO-Controlled Facilities is as provided in Appendix X of the Transmission Owner Tariff.
- i. Delivery Network Upgrades Cost: The Interconnection Customer's share of all costs, excluding One-Time Cost, determined by the Participating TO associated with the design, engineering, procurement, construction and installation of the Participating TO's Delivery Network Upgrades for the First Sequence and the Second Sequence, as applicable. The Delivery Network Upgrades Cost is provided in Appendix A, Section 16.
- j. Delivery Network Upgrades Payment: The sum of the Delivery Network Upgrades Cost and associated One-Time Cost. The Delivery Network Upgrades Payment is provided in Appendix A, Section 18.

- k. Devers RAS: A new SPS that integrates additional generation tripping prior to opening of the AA Banks at Devers Substation.
- l. Distribution Upgrades Cost: All costs, excluding ITCC and One-Time Cost, determined by the Participating TO associated with the design, engineering, procurement, construction and installation of the Distribution Upgrades. The Distribution Upgrades Cost is provided in Appendix A, Section 16.
- m. Distribution Upgrades Payment: The sum of the Distribution Upgrades Cost and the associated One-Time Cost. The Distribution Upgrades Payment is provided in Appendix A, Section 18.
- n. Dracker Project: Interconnection Customer's (or its Affiliates') 485 MW solar photovoltaic generating facility (formally known as the Blythe Solar Power Project) located near Blythe, California as described in Appendix C, Section 1 of this First Amended LGIA.
- o. Financial Close: The close of debt and equity (including tax equity, subordinated, preferred, mezzanine or bridge financing) financing then-anticipated to be sufficient to fully construct a corresponding Electric Generating Unit, as applicable.
- p. First Sequence: This term shall have the meaning ascribed in Appendix A – Recitals to Appendix A.
- q. Identified Affected System: An Affected System operator who either stated that it should be considered an Affected System or whose electric system has been identified by the CAISO as potentially impacted by a generator interconnection through the applicable study process.
- r. Interconnection Facilities Charge: The monthly charge to the Interconnection Customer to recover the revenue requirements for the Participating TO's Interconnection Facilities, calculated as the product of the Customer-Financed Monthly Rate for Non-ISO-Controlled Facilities and the Interconnection Facilities Cost. The Interconnection Facilities Charge is provided in Appendix A, Section 17.
- s. Interconnection Facilities Completion Date: The date upon which the construction of the Participating TO's Interconnection Facilities is complete and such facilities are successfully tested and ready for service.
- t. Interconnection Facilities Cost: All costs, excluding One-Time Cost, determined by the Participating TO to be associated with the design, engineering, procurement, construction and installation of the Participating TO's Interconnection Facilities. The Interconnection Facilities Cost is provided in Appendix A, Section 16.

- u. Interconnection Facilities Payment: The sum of the Interconnection Facilities Cost and associated One-Time Cost. The Interconnection Facilities Payment is provided in Appendix A, Section 18.
- v. ITCC: The ITCC is equal to the estimated tax liability described in Article 5.17.4 of the LGIA, and is the Income Tax Component of Contribution described in the Preliminary Statement, Part M of the Participating TO's tariff on file with the CPUC, applicable to the Distribution Upgrades Cost and Interconnection Facilities Cost. The ITCC applicable to the Distribution Upgrades Cost and Interconnection Facilities Cost is described in Appendix A, Section 11 and is shown in Appendix A, Section 16.
- w. Interim West of Devers Project or Interim WOD Project: The temporary transmission upgrades constructed, owned, operated and maintained by the Participating TO as an interim solution which enables the Dracker Project, and certain other generating facilities to attain Full Capacity Deliverability Status for an interim period, until such time as the Participating TO's Delivery Network Upgrades are constructed and placed in service. The Interim WOD Project is primarily comprised of the installation of series reactor banks on the four existing 220kV transmission lines out of Devers Substation and the Devers RAS to trip the Generating Facility output under certain contingencies.
- x. Letter Agreement: The agreement between Participating TO and Interconnection Customer executed on July 16, 2010 under which Participating TO performed expedited engineering, design, and procurement activities related to the Participating TO's Interconnection Facilities and Participating TO's Reliability Network Upgrades, designated as Service Agreement No. 84 under Participating TO's FERC Electric Tariff, Second Revised Volume No. 6.
- y. One-Time Cost: All costs determined by the Participating TO to be associated with the installation of the Participating TO's Delivery Network Upgrades, Distribution Upgrades, Participating TO's Interconnection Facilities, Participating TO's Reliability Network Upgrades, or Capital Additions which are not capitalized.
- z. Participating TO's Plan of Service Reliability Network Upgrades: Those Participating TO's Reliability Network Upgrades specifically identified in Appendix A, Section 2.b.i.1.
- aa. Potentially Affected System: An electric system in electric proximity to the CAISO Controlled Grid that may be an Affected System.
- bb. Reliability Network Upgrades Cost: The Interconnection Customer's allocated share of all costs, excluding One-Time Cost, determined by the Participating TO associated with the design, engineering, procurement, construction and installation of the Participating TO's Reliability Network Upgrades. The Reliability Network Upgrades Cost is provided in Appendix A, Section 16.

- cc. Reliability Network Upgrades Payment: The sum of the Reliability Network Upgrades Cost and associated One-Time Cost. The Reliability Network Upgrades Payment is provided in Appendix A, Section 18.
- dd. Removal Cost: The actual cost the Participating TO incurs for the removal of the Participating TO's Interconnection Facilities, or any portion thereof, which is calculated as the amount, if positive, of the costs of removal minus the salvage value of the Participating TO's Interconnection Facilities.
- ee. Second Sequence: This term shall have the meaning ascribed in Appendix A – Recitals to Appendix A.
- ff. Special Protection System (“SPS”): A system that reduces or trips generation under contingency outages to maintain system stability or to limit overloads on system facilities.
- gg. Tax Security: Interconnection Customer's provision of Security with respect to Interconnection Customer's tax indemnification obligations, provided in accordance with Article 5.17.3.
- hh. Transmission Owner Tariff: The Participating TO's Tariff designated as FERC Electric Tariff, Volume No. 6, as such tariff may be amended or superseded.
- ii. Units of Property: As described in FERC's “List of Units of Property for Use in Connection with Uniform System of Accounts Prescribed for Public Utilities and Licensees” in effect as of the date of this LGIA, and as such list may be amended from time to time.

**9. Transmission Credits:**

Pursuant to Article 11.4 of the LGIA, the Interconnection Customer elects to receive repayment of the amounts advanced by Interconnection Customer for the costs of the Participating TO's Plan of Service Reliability Network Upgrades for which the associated payment(s) are shown in Appendix A Section 18. Subject to Appendix A, Section 14(d), no Congestion Revenue Rights or repayment will be made pursuant to Articles 11.4 and 11.4.1 of the LGIA for Network Upgrades that the Participating TO has agreed to up-front finance.

**10. Security Amount for the Distribution Upgrades, Participating TO's Interconnection Facilities and Network Upgrades:**

- a. **Distribution Upgrades:** Pursuant to Article 11.5 and Appendix B of the LGIA, the Interconnection Customer shall provide Credit Support in the amount of \$0 to cover the costs for constructing, procuring and installing the Participating TO's Distribution Upgrades.

b. **Participating TO's Interconnection Facilities:**

1. Prior to Interconnection Customer's acquisition of the Dracker Project and execution of the Consent, Participating TO received cash payments from Palo Verde Solar II, LLC in the amount of \$6,400,000 and a letter of credit in the amount of \$2,240,000 pursuant to the Letter Agreement, which were credited towards the amounts due under the LGIA for the Participating TO's Interconnection Facilities and the associated estimated tax liability.
2. On July 11, 2012, in accordance with the Consent, Interconnection Customer provided additional Credit Support (curing the Palo Verde Solar II, LLC delinquencies) in the form of (i) a letter of credit in the amount of \$6,671,000 for the Participating TO's Interconnection Facilities; and (ii) a letter of credit in the amount of \$4,574,850 replacing the aforementioned \$2,240,000 letter of credit provided pursuant to the Letter Agreement for the associated estimated tax liability. As of July 11, 2012 the Participating TO retained a sum of \$13,071,000 in cash/letter of credit for the Participating TO's Interconnection Facilities and a letter of credit in the amount of \$4,574,850 for the associated estimated tax liability based on the cost for such facilities and estimated tax liability in the original LGIA. The estimated Interconnection Facilities Cost have since been revised pursuant to this First Amended LGIA, which has resulted in an excess of cash and Credit Support currently held by the Participating TO.
3. The Participating TO will disburse the cash payments and the Credit Support referenced above in Appendix A, Sections 10.b.1 and 10.b.2 respectively, in accordance with Appendix A, Section 10.b.5 through Section 10.b.8 of this First Amended LGIA.
4. Pursuant to Section 9 of the LGIP, Article 11.5, and Appendix B of this First Amended LGIA, the Interconnection Customer shall provide Credit Support in the amount of \$3,723,201 for the second and third posting to cover the costs for constructing, procuring, and installing the Participating TO's Interconnection Facilities.
5. The requirement in Appendix A, Section 10.b.4 has been satisfied by the cash payments received by the Participating TO pursuant to Appendix A, Section 10.b.2. Such cash deposits have been credited on a dollar-for-dollar basis to the estimated Interconnection Facilities Cost and associated One-Time Cost shown in Appendix A, Section 18 of this First Amended LGIA.
6. The balance of the cash payments received by the Participating TO pursuant to Appendix A, Section 10.b.2. will first be applied towards the Credit Support and estimated Reliability Network Upgrades Cost for the Participating TO's Plan of Service Reliability Network Upgrades (\$2,600,000) as required in Appendix A, Section 10.d. of this First Amended LGIA. Any remaining balance will be refunded to the Interconnection Customer in accordance with Appendix A, Section 10.b.7 of this First Amended LGIA.
7. The Participating TO will refund to Interconnection Customer \$76,799, which is the remaining balance of the cash payments received by the



Participating TO in accordance with Appendix A, Section 10.b.2. (Participating TO and Interconnection Customer may agree that the Participating TO retain such balance pending the results of the final invoice pursuant to Article 12.2 of the LGIA), and release the excess Credit Support in the amount of \$6,671,000 retained by the Participating TO for the Interconnection Facilities. The disposition of any released Credit Support shall be directed by the Interconnection Customer.

8. The remaining Credit Support in the form of a letter of credit in the amount of \$4,574,850 as referenced above in Appendix A, Section 10.b.2 will be managed as specified in Appendix A, Section 11 of this First Amended LGIA.
- c. **Network Upgrades:** Pursuant to Appendix A, Section 14(d), the Participating TO has committed to finance Interconnection Customer's share of the costs of the Network Upgrades, subject to receiving Abandoned Plant Approval, which the Participating TO has received. Subsequent to receiving Abandoned Plant Approval, and pursuant to the Consent and the relevant provisions herein, Participating TO withdrew its commitment to up-front finance the Plan of Service Reliability Network Upgrades as a result of Interconnection Customer not being current with certain project milestones. Pursuant to the Federal Energy Regulatory Commission's Order Granting Waiver of Tariff Provisions in Docket No. ER10-1656-000, issued August 13, 2010, Interconnection Customer's second and third security postings for such Network Upgrades are waived until such time as FERC renders a decision on whether to grant Abandoned Plant Approval, which waiver shall remain in effect in the event Abandoned Plant Approval is granted, so long as Interconnection Customer is current with all milestones as provided in Appendix A, Section 14(d), Table 1 of this LGIA. Because FERC has granted Abandoned Plant Approval, the Interconnection Customer's security posting for Network Upgrades is waived for all such facilities that the Participating TO is continuing to up-front finance, subject to the conditions herein.
  - d. **Participating TO's Plan of Service Reliability Network Upgrades:** Pursuant to Section 9 of the LGIP, Article 11.5 and Appendix B of this First Amended LGIA, the Interconnection Customer shall provide Credit Support in the amount of \$2,600,000 for the third posting to cover the costs for procuring, constructing and installing the Participating TO's Plan of Service Reliability Network Upgrades. This requirement will be satisfied by the cash payments received by the Participating TO pursuant to Appendix A, Section 10.b.2. A total of \$2,600,000 of the cash payments will be credited on a dollar-for-dollar basis to the estimated Reliability Network Upgrades Cost for the Participating TO's Plan of Service Reliability Network Upgrades as shown in Appendix A, Section 18 of this First Amended LGIA.

**11. Security Amount for Estimated Tax Liability:** Pursuant to Article 5.17.4 of the LGIA, the Interconnection Customer's estimated tax liability is as follows:

$(\text{Current Tax Rate} \times (\text{Gross Income Amount} - \text{Present Value of Tax Depreciation})) / (1 - \text{Current Tax Rate}) = 35\%$

Estimated tax liability for Participating TO's Interconnection Facilities = 35% \*  
(Interconnection Facilities Cost) = 35% \* (\$3,533,477) = \$1,236,717

Interconnection Facilities Cost = \$3,533,477

Based upon the total estimated tax liability, the Interconnection Customer shall provide the Participating TO a cash deposit in an escrow account or a letter of credit in the amount of \$1,236,717, pursuant to Article 5.17.3 and Appendix B of this First Amended LGIA.

This requirement has been satisfied by the letter of credit in the amount of \$4,574,850 received by the Participating TO pursuant to Appendix A, Section 10.b.2. Interconnection Customer may reduce such letter of credit to no less than \$1,236,717 based on the revised Interconnection Facilities Cost in this First Amended LGIA.

Upon notification of the Annual Tax Security Reassessment, the Interconnection Customer shall modify its Tax Security accordingly. If the Annual Tax Security Reassessment results in a deficiency in the Tax Security amount, the Interconnection Customer will be required to increase its Tax Security amount within 30 days after receipt of the deficiency notification. If the Annual Tax Security Reassessment results in a reduction of the Tax Security amount, the Interconnection Customer may choose to reduce its Tax Security amount or maintain the Tax Security in the current amount for the following year.

The Annual Tax Security Reassessment will be calculated utilizing the following methodology:

1) Tax Assessment Event:

$((\text{Current Tax Rate} \times (\text{Gross income} - \text{NPV Tax Depreciation})) + \text{Interest}) / (1 - \text{Current Tax Rate})$

2) Subsequent Taxable Event:

$(\text{Current Tax Rate} \times (\text{Replacement Facility Cost} - \text{NPV Tax Depreciation})) / (1 - \text{Current Tax Rate})$

**12. Security Amount for Partial Termination Charge:**

- a. **Amount:** The amount of the Partial Termination Charge Security shall equal \$6,136,025 for each Electric Generating Unit that the Interconnection Customer elects to be eligible for Partial Termination. With respect to the Phased

Generating Facility, Interconnection Customer shall be entitled (upon providing the Partial Termination Security to the CAISO) to secure Partial Termination rights with respect to Electric Generating Units 2, 3 and/or 4, which, if the Interconnection Customer secures Partial Termination rights to all three (3) Electric Generating Units comprising 375 MW, would result in a maximum Partial Termination Charge Security of \$18,408,075. The Interconnection Customer shall make its election and designation of the Electric Generating Unit(s) to be eligible for Partial Termination at the time of the Partial Termination Charge Security posting. The Parties acknowledge that Partial Termination shall not be available for Electric Generating Unit 1, and that Electric Generating Unit 1 shall not be the subject of a Partial Termination pursuant to this LGIA.

- b. **Timing for Posting of Partial Termination Charge Security:** The entire amount of the Partial Termination Charge Security for all Electric Generating Units for which the Interconnection Customer elects to secure eligibility for Partial Termination shall be posted no later than thirty (30) Calendar Days following the later of (i) the Financial Close for Electric Generating Unit 1 of the First Sequence or (ii) the Participating TO's final receipt of Abandoned Plant Approval; provided, however, that under no circumstances shall the Partial Termination Charge Security be delivered after 5:00 PM Pacific Standard Time on April 7, 2012. In the event that the Interconnection Customer fails to timely post the Partial Termination Charge Security, then, as specified in Article 2.4.4, the provisions of this LGIA permitting Partial Termination shall not be operative and termination of this LGIA may only occur with respect to the entire Generating Facility.
- c. **Reduction of Partial Termination Charge Security for Electric Generating Units that Achieve Commercial Operation Prior to Termination:** Within fifteen (15) Calendar Days following Commercial Operation of each Electric Generating Unit for which Partial Termination has been secured and not exercised, the Partial Termination Charge Security shall be reduced by the amount \$6,136,025. If the Interconnection Customer had posted security in the form of a cash deposit, such cash funds shall be released and/or returned to the Interconnection Customer. If the Interconnection Customer posts another form of financial security of the type specified in CAISO Cluster LGIP (CAISO Tariff App. Y) Section 9.1, the Parties shall cooperate and execute such necessary documents as to accomplish a replacement security in the lower amount or take other action necessary to accomplish the reduction in Partial Termination Charge Security.

**13. Removal of the Participating TO's Interconnection Facilities and Distribution Upgrades:** Following termination of the LGIA in its entirety, the Participating TO will remove the Participating TO's Interconnection Facilities and Distribution Upgrades from service to the Interconnection Customer pursuant to Article 2.5 of the LGIA. On or before the date one year following termination of the LGIA, the Participating TO shall notify the Interconnection Customer whether the Participating TO intends to physically remove the Participating TO's Interconnection Facilities, Distribution Upgrades, or any part thereof. If the Participating TO intends to physically remove

the Participating TO's Interconnection Facilities, or any part thereof, then the Participating TO shall physically remove such facilities within two years from the date of notification of intent, and the Interconnection Customer shall pay the Removal Cost. If the Participating TO does not intend to physically remove the Participating TO's Interconnection Facilities, or any part thereof, then the Interconnection Customer shall have no obligation to pay such Removal Cost.

- a. In the event the large generator interconnection agreement for the generating facility having CAISO Queue No. 193 is terminated and the Interim WOD Project has not been removed from service or otherwise integrated into the CAISO Controlled Grid as a permanent network upgrade, then this LGIA may be amended to reflect that Removal Cost and the associated provisions herein include the Interim WOD Project, only to the extent that the generating facility having CAISO Queue No. 193 has not fulfilled its cost obligations associated with such Removal Cost. Any such amendment shall be subject to FERC acceptance.

#### **14. Charges:**

- a. The Interconnection Customer shall pay to the Participating TO the following charges in accordance with the LGIA: (i) Distribution Upgrades Payment (if applicable); (ii) Delivery Network Upgrades Payment (if applicable); (iii) Interconnection Facilities Payment; (iv) Reliability Network Upgrades Payment; (v) payments for any Capital Additions; (vi) Interconnection Facilities Charge; (vii) any reimbursable FERC fees pursuant to Appendix A, Section 15(i); (viii) Removal Cost pursuant to Article 2.4.3 of the LGIA and Appendix A, Section 15(h); (ix) termination charges pursuant to Article 2.4 of the LGIA, provided that such charges shall not be applicable to the extent the costs associated with the Network Upgrades are subject to Abandoned Plant Approval received by the Participating TO; (x) disconnection costs pursuant to Article 2.5 of the LGIA; and (xi) any suspension costs pursuant to Article 5.16 of the LGIA.
- b. The Distribution Upgrades Cost, Delivery Network Upgrades Cost, Interconnection Facilities Cost, Reliability Network Upgrades Cost, associated One-Time Cost and Removal Cost shall be compiled in accordance with Accounting Practice.
- c. If, during the term of the LGIA, the Participating TO executes an agreement to provide service to another entity (other than for retail load) which contributes to a need for the Participating TO's Interconnection Facilities, the charges due hereunder may be adjusted to appropriately reflect such service based on the Participating TO's cost allocation principles in effect at such time, and shall be subject to FERC's approval.
- d. The Participating TO commits to up-front finance the cost of the Network Upgrades including the associated One-Time Cost specifically identified in

Appendix A, Section 2. Such upgrades shall exclude the Participating TO's Plan of Service Reliability Network Upgrades. The Participating TO's commitment to up-front finance the remaining Network Upgrades shall be contingent upon satisfactory receipt, as determined solely by the Participating TO, of the following:

- i. Abandoned Plant Approval: If Participating TO has not received Abandoned Plant Approval within six (6) months (or such longer period mutually agreed to by the Parties) of applying for such approval, the Parties will negotiate an amendment to this LGIA. *The Participating TO has received Abandoned Plant Approval.*
- ii. The continued achievement of the milestones and decision points, as described in Table 1 below, by the Interconnection Customer, as such milestones and decision points may be adjusted pursuant to Option 2 of Table 2b below. The Interconnection Customer has agreed to the following condition: if the Interconnection Customer has not achieved Commercial Operation of Electric Generating Units 2, 3 or 4 by the in-service date of the Network Upgrades necessary to provide the entire Generating Facility with full deliverability (the "Outside Date"), the Participating TO shall have the right, upon sixty (60) Calendar Days prior written notice, to: (A) upon mutual determination of the CAISO and the Participating TO that an event of Partial Termination has occurred and notice of the same as provided for in Article 2.4.4.2, request that the CAISO liquidate the Partial Termination Charge Security applicable to the Electric Generating Units that have not achieved Commercial Operation by the Outside Date, and (B) terminate this LGIA solely with respect to the Electric Generating Units that have not achieved Commercial Operation by the Outside Date, and apply the proceeds of the Partial Termination Charge as provided for in Article 2.4.4.5. If the Interconnection Customer has not commenced construction activities on Electric Generating Unit 2, 3 or 4 within twelve (12) months prior to the Outside Date, the Participating TO may exercise the foregoing rights within such twelve (12) month period. In the event the Participating TO exercises the foregoing rights, the LGIA shall remain in full force and effect with respect to each Electric Generating Unit that has achieved Commercial Operation prior to the Participating TO's exercise of its foregoing rights, and the Parties shall amend this LGIA to reflect the lower interconnection capacity.

**Table 1: Participating TO and Interconnection Customer Milestones and Decision Points**

<b>Group 1 Milestones and Decision Point #1 for First Sequence</b>	
<b>Participating TO Milestone</b>	<b>Interconnection Customer Milestone</b>
<ul style="list-style-type: none"> <li>• Participating TO applies for Abandoned Plant Approval.</li> <li>• Participating TO commences final design and engineering of the Reliability Network Upgrades.</li> </ul>	<ul style="list-style-type: none"> <li>• Interconnection Customer secures final Site Exclusivity as defined in the LGIP.</li> <li>• Interconnection Customer has provided Interconnection Financial Security in accordance with Section 9 of the LGIP and applicable FERC orders.</li> </ul>
<p>DECISION POINT #1: Following Participating TO's written notification of Participating TO's completion of all of its Group 1 milestones, the Interconnection Customer must demonstrate that it has completed all of its Group 1 milestones within ninety (90) Calendar Days of the Participating TO's such notification. Parties exercise options as outlined in Table 2.</p>	
<b>Group 2 Milestones and Decision Point #2 for First Sequence</b>	
<b>Participating TO Milestone</b>	<b>Interconnection Customer Milestone</b>
<ul style="list-style-type: none"> <li>• Participating TO receives Abandoned Plant Approval.</li> <li>• Participating TO secures all discretionary permits, licenses, and property rights for the Participating TO's Interconnection Facilities for the First Sequence and Participating TO's Reliability Network Upgrades.</li> </ul>	<ul style="list-style-type: none"> <li>• Interconnection Customer secures all discretionary permits, licenses, and property rights required for the construction of the First Sequence of the Generating Facility and Interconnection Customer's First Sequence Interconnection Facilities.</li> </ul>
<p>DECISION POINT #2: Following Participating TO's written notification of Participating TO's completion of all of its Group 2 milestones, the Interconnection Customer must demonstrate that it has completed all of its Group 2 milestones within ninety (90) Calendar Days of the Participating TO's such notification. Parties exercise options as outlined in Table 2.</p>	

**Group 3 Milestones and Decision Point #3 for First Sequence**

Participating TO Milestone	Interconnection Customer Milestone
<ul style="list-style-type: none"> <li>• Participating TO completes final design and engineering, for the Participating TO's Interconnection Facilities for the First Sequence and Participating TO's Reliability Network Upgrades.</li> <li>• Participating TO notifies Interconnection Customer that Participating TO is prepared to commence Construction Activities within ninety (90) Calendar Days.</li> </ul>	<ul style="list-style-type: none"> <li>• Interconnection Customer selects Engineering, Procurement and Construction ("EPC") contractor.</li> <li>• Interconnection Customer secures Financial Close for at least one Electric Generating Unit of the First Sequence.</li> <li>• If Interconnection Customer has elected Partial Termination of Electric Generating Unit 2, then the Participating TO shall have the option, at its sole discretion, not to commence any Construction Activities for any Delivery Network Upgrades associated with the First Sequence.</li> </ul>

DECISION POINT #3: Following Participating TO's written notification of Participating TO's completion of all of its Group 3 milestones, the Interconnection Customer must demonstrate that it has completed all of its Group 3 milestones within ninety (90) Calendar Days of the Participating TO's notification, which notification shall be no earlier than July 1, 2011. Parties exercise options as outlined in Table 2.

**Group 4 Milestones and Decision Point #4 for First Sequence**

Participating TO Milestone	Interconnection Customer Milestone
<ul style="list-style-type: none"> <li>• Participating TO commences Construction Activities of the Participating TO's Reliability Network Upgrades.</li> </ul>	<ul style="list-style-type: none"> <li>• Interconnection Customer commences construction activities of at least one Electric Generating Unit of the First Sequence.</li> </ul>

DECISION POINT #4: Following Participating TO's written notification of Participating TO's completion of all of its Group 4 milestones, the Interconnection Customer must demonstrate that it has completed all of its Group 4 milestones within thirty (30) Calendar Days of the Participating TO's notification, which notification shall be no earlier than November 1, 2011. Parties exercise options as outlined in Table 2.

*Prior to the assignment of the LGIA from Palo Verde II, LLC to NextEra Blythe Solar Energy Center, LLC, Interconnection Customer was unable to timely demonstrate that it*

*had completed all of its above Group 1 through Group 4 milestones. As a result, and in accordance with Table 2A below, Participating TO elected to discontinue its commitment to up-front finance the Participating TO's Plan of Service Reliability Network Upgrades. By providing cash payment in accordance with Appendix A Section 18 for the Participating TO's Plan of Service Reliability Network Upgrades, the Interconnection Customer has cured its default with respect to missing the Group 1 through Group 4 milestones. Participating TO's commitment to up-front finance Interconnection Customer's share of the remaining Network Upgrades is contingent upon Interconnection Customer's achievement of the following remaining milestones and decision points, which shall be subject to the options as provided for in Table 2A below.*

**Group 5 Milestones and Decision Point #5 for First Sequence**

<b>Participating TO Milestone</b>	<b>Interconnection Customer Milestone</b>
<ul style="list-style-type: none"> <li>Participating TO energizes the Participating TO's Reliability Network Upgrades, enabling Commercial Operation of the First Sequence of the Generating Facility.</li> </ul>	<ul style="list-style-type: none"> <li>Interconnection Customer achieves Initial Synchronization Date for at least one Electric Generating Unit of the First Sequence.</li> </ul>

**DECISION POINT #5:** Following Participating TO's written notification of Participating TO's completion of all of its Group 5 milestones, the Interconnection Customer must demonstrate that it has completed all of its Group 5 milestones within ninety (90) Calendar Days of the Participating TO's notification, which shall be no earlier than December 1, 2015. Parties exercise options as outlined in Table 2. Interconnection Customer must also subsequently demonstrate that it has commenced generating electricity for sale, excluding electricity generated during Trial Operation, for at least one 110 MW Electric Generating Unit of the First Sequence by May 30, 2016.



<b>Group 1 Milestones and Decision Point #1 for the Second Sequence</b>	
<b>Participating TO Milestone</b>	<b>Interconnection Customer Milestone</b>
<ul style="list-style-type: none"> <li>• Participating TO completes final design and engineering for the Participating TO's Delivery Network Upgrades</li> <li>• Participating TO commences procurement of major material and equipment for the Participating TO's Delivery Network Upgrades</li> <li>• Participating TO secures all permits, licenses, and property rights for the Participating TO's Delivery Network Upgrades</li> </ul>	<ul style="list-style-type: none"> <li>• Interconnection Customer secures all remaining permits, licenses, and property rights required for the construction of the Second Sequence</li> <li>• Interconnection Customer obtains a power purchase agreement for at least one unit of the Second Sequence</li> </ul>
<p>DECISION POINT #1: Following Participating TO's written notification of Participating TO's completion of all of its Group 1 milestones, the Interconnection Customer must demonstrate that it has completed all of its Group 1 milestones within ninety (90) Calendar Days of the Participating TO's notification, which notification shall be no earlier than October 1, 2016. Parties exercise options as outlined in Table 2.</p>	
<b>Group 2 Milestones and Decision Point #2 for the Second Sequence</b>	
<b>Participating TO Milestone</b>	<b>Interconnection Customer Milestone</b>
<ul style="list-style-type: none"> <li>• Participating TO commences construction for the Participating TO's Delivery Network Upgrades</li> </ul> <p>If Interconnection Customer has elected Partial Termination of the Second Sequence, then the Participating TO has no obligation to commence construction for any Participating TO's Delivery Network Upgrades that would otherwise be required for the Second Sequence.</p>	<ul style="list-style-type: none"> <li>• Interconnection Customer secures Financial Close, or its board approval if financing is carried on Interconnection Customer's balance sheet, to construct at least one unit of the Second Sequence</li> </ul>
<p>DECISION POINT #2: Following Participating TO's written notification of Participating TO's completion of all of its Group 2 milestones, the Interconnection Customer must demonstrate that it has completed all of its Group 2 milestones within ninety (90) Calendar Days of the Participating TO's notification, which notification shall be no earlier than July 1, 2017.</p>	

Parties exercise options as outlined in Table 2.

**Group 3 Milestones and Decision Point #3 for the Second Sequence**

<b>Participating TO Milestone</b>	<b>Interconnection Customer Milestone</b>
<ul style="list-style-type: none"> <li>Participating TO provides written notice to the Interconnection Customer that Participating TO estimates completion of Participating TO's Delivery Network Upgrades in eighteen (18) months</li> </ul>	<ul style="list-style-type: none"> <li>Interconnection Customer executes contracts for Engineering, Procurement and Construction ("EPC") contractor for at least one unit of the Second Sequence. If the Interconnection Customer elects to self-build the project, an engineering services firm will be engaged and contracts for procurement of long lead/major equipment for at least one unit of the Second Sequence will be executed</li> <li>Interconnection Customer commences construction for the Second Sequence</li> </ul>

DECISION POINT #3: Following Participating TO's written notification of Participating TO's completion of all of its Group 3 milestones, the Interconnection Customer must demonstrate that it has completed all of its Group 3 milestones within ninety (90) Calendar Days of the Participating TO's notification, which notification shall be no earlier than January 1, 2020. Parties exercise options as outlined in Table 2.

**Group 4 Milestones and Decision Point #4 for the Second Sequence**

<b>Participating TO Milestone</b>	<b>Interconnection Customer Milestone</b>
<ul style="list-style-type: none"> <li>Participating TO completes construction and energizes the Participating TO's Delivery Network Upgrades</li> </ul>	<ul style="list-style-type: none"> <li>Interconnection Customer achieves Initial Synchronization Date for at least one Electric Generating Unit of the Second Sequence</li> <li>Interconnection Customer commences generating electricity for sale, excluding electricity generated during Trial Operation, of at least one Electric Generating Unit of the Second Sequence of the Generating</li> </ul>

	Facility
<p>DECISION POINT #4: Following Participating TO's written notification of Participating TO's completion of all of its Group 4 milestones, the Interconnection Customer must demonstrate that it has completed all of its Group 4 milestones within ninety (90) Calendar Days of the Participating TO's notification, which notification shall be no earlier than August 1, 2021. Parties exercise options as outlined in Table 2.</p>	

**Table 2: Actions by the Parties at each Decision Point:**

Table 2A- Participating TO General Option: At each Decision Point, the Participating TO has the following options:

At each Decision Point as set forth in Table 1 above and Section 14(d)(ii), if the Interconnection Customer is current in meeting its milestones set forth in Table 1 above and Section 14(d)(ii) (as such milestones may be adjusted due to the Interconnection Customer exercising Option 2 in Table 2B below), the Participating TO shall confirm its commitment, subject to Section 14(d)(i), to finance Network Upgrades for the applicable sequence for which the milestones have been met.

If the Interconnection Customer is not current in meeting its milestones as set forth in Table 1 (as such milestones may be adjusted due to the Interconnection Customer exercising Option 2 in Table 2B below), the Participating TO has the following options:

1. Confirm its commitment to finance the applicable Network Upgrades (but have no obligation to do so).
2. Discontinue its commitment to finance the applicable Network Upgrades, in which case the Parties shall negotiate amendments to this LGIA pursuant to the discussion in the Recitals to Appendix A and operative provisions of this Appendix A.
3. Extend the applicable deadline for Interconnection Customer to satisfy the milestone requirement for the Electric Generating Units.
4. Terminate this LGIA, subject to the termination and Partial Termination provisions of this LGIA.
5. Other actions mutually agreeable to the Parties.

The Participating TO will provide written notification to the Interconnection Customer of the option selected.

Table 2B – Interconnection Customer General Option: At each Decision Point, the Interconnection Customer has the following options:

At each Decision Point as set forth in Table 1 above, if the Participating TO is current in meeting its milestones in Table 1 above, the Interconnection Customer shall confirm its non-binding intention to develop the Electric Generating Units for which the milestone has been met.

If the Participating TO is not current in meeting its milestones as set forth in Table 1 (as such milestones may be adjusted due to the Participating TO exercising Option 2 in Table 2a above), the Interconnection Customer has the following options:

1. Continue to develop the Electric Generating Units for which the milestone has

not been met (but have no obligation to do so).

2. Adjust its milestones for the applicable Electric Generating Units in Table 1 above, on a day-for-day basis, as appropriate, to the Participating TO's new timetable(s).
3. (a) If the Participating TO is not current in meeting its milestones with respect to the First Sequence, the Interconnection Customer shall have the right to (1) terminate the LGIA in its entirety, with resulting disconnection of the First Sequence, and cause the refund of the Partial Termination Charge Security in full to Interconnection Customer, or (2) invoke Partial Termination of this LGIA with respect to Electric Generating Unit 2 pursuant to Article 2.4.4, provided that the Interconnection Customer has previously posted Partial Termination Charge Security for Unit 2.  
(b) If the Participating TO is not current in meeting its milestones with respect to the Second Sequence, the Interconnection Customer shall have the right to invoke Partial Termination of this LGIA in accordance with Article 2.4.4 with respect to either or both Electric Generating Units within the Second Sequence.\*
4. Terminate this LGIA, subject to the termination and Partial Termination provisions of this LGIA.
5. Other actions mutually agreeable to the Parties.

The Interconnection Customer will provide written notification to both the CAISO and the Participating TO of the option selected.

If the Participating TO is unable to complete the Network Upgrades necessary to provide full deliverability to the entire Generating Facility, the Participating TO shall use commercially Reasonable Efforts to pursue alternatives to provide full deliverability to the entire Generating Facility.

\* The termination provisions provided above (Option 3(a) and (b)) reflect that the Interconnection Customer may invoke a Partial Termination under Section 2.4.4 with respect to those Electric Generating Units for which the Interconnection Customer has previously provided Partial Termination Charge Security, which right of Partial Termination is alternative to the Interconnection Customer's choice of termination of the entire LGIA under Article 2.3 of this LGIA.

If, within seventy-two (72) months of the Effective Date of the LGIA, the Participating TO has not (i) commenced construction of the West of Devers Network Upgrades or (ii) made commercially Reasonable Efforts to provide an alternative solution for ensuring timely full capacity deliverability status for the Generating Facility, and either (a) the Interconnection Customer (or an owner thereof who has signed the Joinder Agreement referred to in Appendix C, Section 9) is in default of a power purchase agreement or cannot perform under a power purchase agreement as a result thereof, or (b) the Parties otherwise reasonably agree that the Interconnection Customer (or any owner thereof who has signed the Joinder Agreement referred to in Appendix C,

Section 9) has been harmed as a result of the Participating TO's failure to complete the West of Devers Network Upgrades (or otherwise provide full capacity deliverability status for the Generating Facility) in a timely manner, then the Interconnection Customer shall have the right to invoke a Partial Termination of this LGIA with respect to the Electric Generating Units that the Interconnection Customer reasonably demonstrates to the other Parties it is unable to construct. If Partial Termination is exercised under the terms of the foregoing sentence, the Participating TO and the CAISO shall return the Partial Termination Charge Security applicable to such terminated Electric Generating Units to the Interconnection Customer. Any Partial Termination exercised by the Interconnection Customer, other than in accordance with this paragraph, shall result in the CAISO and the Participating TO liquidating the Partial Termination Charge Security applicable to the terminated Electric Generating Units in accordance with Article 2.4.4.5 of this LGIA.

- e. The determination of whether the Interconnection Customer has met its milestones outlined in Table 1 under Section 14(d) above shall be at the reasonable discretion of the Participating TO. The determination of whether the Participating TO has met its milestones outlined in Table 1 under Section 14(d) above shall be at the reasonable discretion of the Interconnection Customer. If there is a dispute as to whether the Interconnection Customer or Participating TO has met a milestone required in Table 1 under Section 14.d. above, such dispute shall be resolved pursuant to Article 27 of the LGIA.
- f. The Participating TO is under no obligation to finance other network upgrades if the Network Upgrades are modified pursuant to the LGIP and such modification results in the Participating TO having to reaffirm Abandoned Plant Approval for the modified Network Upgrades. The Participating TO may seek reaffirmation of Abandoned Plant Approval for any modified Network Upgrades, at its sole discretion. If (i) the reaffirmation of Abandoned Plant Approval for the modified Network Upgrades is not reached within six (6) months (or such longer period mutually agreed to by the Parties) of applying for such reaffirmation, or (ii) the Participating TO does not seek reaffirmation of Abandoned Plant Approval, the Parties agree to amend this LGIA subject to the conditions described in the Recitals to Appendix A portion of this Appendix A. With the exception of Interconnection Customer exercising its Partial Termination rights pursuant to Article 2.4.4, if the Interconnection Customer does not meet any one of the milestones specified in Table 1 under Section 14.d. above (as such milestones may be adjusted due to the Interconnection Customer exercising option 2 in Table 2B above), this failure shall be considered a Breach of this LGIA, subject to the Default and Right to Terminate provisions under Article 17 of this LGIA. Each milestone in Table 1 of Section 14.d. shall be subject to the Force Majeure provisions of this LGIA.
- g. Notwithstanding anything to the contrary in Table 2A under Section 14.d., Interconnection Customer shall not be in Breach of this LGIA, and the

Participating TO shall not have the right to terminate this LGIA, as a result of the Interconnection Customer missing a milestone in Table 1 under Section 14(d), provided that the Parties: (i) reasonably and in good faith negotiate an amendment of this LGIA to provide for Interconnection Customer-financing of the Network Upgrades; and (ii) reach agreement on such amendment within sixty (60) Calendar Days after Participating TO's notification of its having exercised option 2 or 4 under Appendix A, Section 14.d., Table 2A.

- h. Each Party shall provide the other Parties with a monthly status report, including all supporting documentation, to verify that Party's progress on the milestones outlined in Table 1 under Section 14.d. above.
- i. The Participating TO shall endeavor to file with FERC for Abandoned Plant Approval within sixty (60) Calendar Days of execution and filing of this LGIA.
- j. At no time will the Participating TO require payment from the Interconnection Customer for any Network Upgrades for which Abandoned Plant Approval has been obtained and for which the Participating TO has committed to up-front finance, provided that the costs of such Network Upgrades are incurred while the Interconnection Customer is current with meeting its development milestones pursuant to Section 14.d.
- k. In accordance with its notice to the Participating TO and the CAISO dated May 22, 2013, the interconnection customer for the generating facility having CAISO Queue No. 193 confirmed its agreement to pay the full costs of the Interim WOD Project as such costs have been incorporated into the CAISO Queue No. 193 large generator interconnection agreement. Accordingly, the Dracker Project is not allocated a share of the Interim WOD Project costs in this First Amended LGIA. However, in the event the CAISO Queue No. 193 large generator interconnection agreement is terminated and the Interim WOD Project has not been removed from service or otherwise integrated into the CAISO Controlled Grid as a permanent network upgrade, then this LGIA may be amended to reflect that Interconnection Customer will be responsible for certain ongoing charges associated with the Interim WOD Project in accordance with Appendix A, Sections 13.a., 15.d., and 15.g. of this First Amended LGIA.

**15. Supplemental Billing and Payment Provisions:**

- a. Pursuant to Article 12.1 of the LGIA, the Participating TO shall submit to the Interconnection Customer invoices due for the preceding month for the Distribution Upgrades Payment, Delivery Network Upgrades Payment, Interconnection Facilities Payment, and Reliability Network Upgrades Payment.
- b. Pursuant to Article 10.5 of the LGIA, commencing on or following the Interconnection Facilities Completion Date, each month the Participating TO will render bills to the Interconnection Customer for the Interconnection Facilities

Charge. The Interconnection Facilities Charge payments shall initially be based on the estimated Interconnection Facilities Cost as specified in Appendix A, Section 16 of this LGIA, and shall be subject to later adjustment pursuant to Section 15.b.(i) and 15.b.ii. The Interconnection Facilities Charge for the first and last month of service hereunder shall be pro-rated based on the number of Calendar Days in which service was provided during said months.

- i. If the amounts paid for the Interconnection Facilities Charge are less than the amounts due for the Interconnection Facilities Charge as determined from the actual recorded Interconnection Facilities Cost, Participating TO will bill Interconnection Customer the difference between the amounts previously paid by Interconnection Customer and the amounts which would have been paid based on actual recorded costs, without interest, on the next regular billing.
  - ii. If the amounts paid for the Interconnection Facilities Charge are greater than the amounts due for the Interconnection Facilities Charge as determined from the actual recorded Interconnection Facilities Cost, Participating TO will credit Interconnection Customer the difference between the amounts previously paid by Interconnection Customer and the amounts which would have been paid based on actual recorded costs, without interest, on the next regular billing.
- c. In the event that any portion of Participating TO's Interconnection Facilities is not complete but, at the request of Interconnection Customer, Participating TO commences Interconnection Service under this LGIA notwithstanding the incomplete facilities, Participating TO shall commence billing, and Interconnection Customer shall pay, the Interconnection Facilities Charge commencing on the date that such service commences.
- d. In the event the large generator interconnection agreement for the generating facility having CAISO Queue No. 193 is terminated and the Interim WOD Project has not been removed from service or otherwise integrated into the CAISO Controlled Grid as a permanent network upgrade, then this LGIA shall be amended to reflect that the Interconnection Customer shall be responsible for the ongoing monthly operations and maintenance charge associated with the Interim WOD Project. Any such amendment shall be subject to FERC acceptance.
- e. In accordance with Article 5.19.3 of the LGIA, the Participating TO shall submit to the Interconnection Customer invoices due for the preceding month for the payments due for Capital Additions, if any.
- i. For Capital Additions that are the cost responsibility of the Interconnection Customer, prior to commencing work, the Participating TO will provide at least sixty (60) Calendar Days advance written notification to the Interconnection Customer, except that, at the Participating TO's sole discretion, the Participating TO may commence the work on the Capital Additions with either shorter advance written notification or written notification after the work has commenced if the Participating TO determines that the Capital Additions are



- required in accordance with safety or regulatory requirements or to preserve system integrity or reliability. The written notification will include the estimated cost of the Capital Additions, and the amount of and due date for the security, if any, required to be paid by the Interconnection Customer sufficient to cover the costs for constructing, procuring and installing the Capital Additions consistent with the applicable terms of Article 11.5 of the LGIA.
- ii. Except as provided in Section 8.c. above, if certain Participating TO's Interconnection Facilities are removed to accommodate Capital Additions and such removal results in a change in the Interconnection Facilities Cost, the Interconnection Facilities Charge shall be adjusted as of the in-service date of such Capital Additions to reflect the change in the Interconnection Facilities Cost.
  - iii. Except as provided in Section 8.c. above, if Capital Additions result in an increase in the Interconnection Facilities Cost, then the Interconnection Facilities Charge shall be adjusted as of the in-service date of such Capital Additions to reflect the change in such costs.
- f. As soon as reasonably practicable, but within twelve (12) months after the in-service date of any Capital Additions, the Participating TO shall provide an invoice of the final cost of the construction of the Capital Additions to the Interconnection Customer, and shall set forth such costs in sufficient detail to enable the Interconnection Customer to compare the actual costs with the estimates and to ascertain deviations, if any, from the cost estimates. The Participating TO shall refund to the Interconnection Customer any amount by which the payment made by the Interconnection Customer for estimated costs of the Capital Additions exceeds the actual costs of construction within thirty (30) Calendar Days of the issuance of such final construction invoice; or, in the event the actual costs of construction exceed the Interconnection Customer's payment made for the estimated costs of the Capital Additions, then the Interconnection Customer shall pay to the Participating TO any amount by which the actual costs of construction exceed the payment made by the Interconnection Customer for estimated costs within thirty (30) Calendar Days of the issuance of such final construction invoice.
- g. In the event the large generator interconnection agreement for the generating facility having CAISO Queue No. 193 is terminated and the Interim WOD Project has not been removed from service or otherwise integrated into the CAISO Controlled Grid as a permanent network upgrade, then this LGIA shall be amended to reflect that Capital Additions and the related provisions herein include the Interim WOD Project. Any such amendment shall be subject to FERC acceptance.
- h. If, in accordance with the removal of the Participating TO's Interconnection Facilities specified in Section 13 above, the Participating TO decides to physically remove the Participating TO's Interconnection Facilities, or any part thereof, the Participating TO shall render a bill to the Interconnection Customer

for the Removal Cost. The Interconnection Customer shall pay the Removal Cost in accordance with Article 2.4.3 of the LGIA. Such billing shall initially be based on the Participating TO's estimate of the Removal Cost. Within twelve (12) months following the removal of the Participating TO's Interconnection Facilities, or any part thereof, the Participating TO shall determine the actual Removal Cost and provide the Interconnection Customer with a final invoice. The Participating TO shall refund to the Interconnection Customer any amount by which the payment by the Interconnection Customer for the estimated Removal Cost exceeds the actual Removal Cost within thirty (30) Calendar Days of the issuance of such final invoice; or, in the event the actual Removal Cost exceeds the Interconnection Customer's payment for the estimated Removal Cost, then the Interconnection Customer shall pay to the Participating TO any amount by which the actual Removal Cost exceeds the payment by the Interconnection Customer for the estimated Removal Cost within thirty (30) Calendar Days of the issuance of such final invoice.

- i. The Interconnection Customer shall reimburse the Participating TO for all fees and charges related to the FERC fees and annual charges provided in Sections 381 and 382 of the FERC's regulations (18 C.F.R. § 381 and 382), as such regulation may from time to time be amended, that are imposed on the Participating TO attributable to the service provided under the LGIA, or any amendments thereto. The Participating TO will render bills to the Interconnection Customer for any such fees and charges incurred since the preceding billing. As of the Effective Date, no such fees and charges have been imposed on the Participating TO attributable to the service provided under the LGIA.
- j. In accordance with the Letter Agreement, this LGIA will supersede the Letter Agreement upon the Effective Date and Interconnection Customer's deposits made pursuant to the Letter Agreement will be credited to the amounts due under this LGIA.

**16. Distribution Upgrades Cost, Reliability Network Upgrades Cost, Delivery Network Upgrades Cost and Interconnection Facilities Cost Summary:**

(The amounts listed in the following table for the Interconnection Facilities and Plan of Service Reliability Network Upgrades are shown in nominal dollars based on a Year 2013 completion date for the Plan of Service Reliability Network Upgrades and an estimated December 2015 completion date for the Interconnection Facilities. The amounts for the remaining Network Upgrades are shown in 2010 constant dollars consistent with the Phase II Interconnection Study report and Appendix G of this LGIA.)

Estimated Cost:

Element	Inter-connection Facilities Cost	Distribution Upgrade Costs	Plan of Service Reliability Network Upgrades Cost	Delivery Network Upgrades Cost*	Reliability Network Upgrades Costs*	One-Time Cost	ITCC**
PTO's Inter-connection Facilities	\$3,533,477					\$189,724	\$1,236,717
Distribution Upgrades		\$0					
Plan of Service Reliability Network Upgrades			\$2,600,000				
Reliability Network Upgrades					\$55,734,000		
Delivery Network Upgrades				\$207,944,000			
<b>Total-</b>	<b>\$3,533,477</b>	<b>\$0</b>	<b>\$2,600,000</b>	<b>\$207,944,000</b>	<b>\$55,734,000</b>	<b>\$189,724</b>	<b>\$1,236,717</b>

Notes:

\* Network Upgrades costs, excluding the costs associated with the Participating TO's Plan of Service Reliability Network Upgrades, are shown for information purposes only since the Participating TO has agreed to up-front finance these Network Upgrades, subject to Appendix A, Section 14.d.

\*\* ITCC will be provided by Interconnection Customer in accordance with Appendix A, Section 11.

Actual Cost:

[TO BE INSERTED AFTER TRUE-UP OF ACTUAL COSTS]

Element	Interconnection Facilities Cost	Distribution Upgrades Cost	Reliability Network Upgrades Cost	Delivery Network Upgrades Cost	One-Time Cost	Total Cost	ITCC
Total							

**17. Interconnection Facilities Charge:**

Interconnection Facilities Charge:

Interconnection Facilities Charge Effective Date	Customer-Financed Monthly Rate for Non-ISO-Controlled Facilities	Estimated		Actual	
		Interconnection Facilities Cost	Interconnection Facilities Charge Based on Estimated Cost	Actual Interconnection Facilities Cost	Interconnection Facilities Charge based on actual cost
As of the Interconnection Facilities Completion Date	See Section 4.1 of Appendix X to the Transmission Owner Tariff*	\$3,533,477	Customer-Financed Monthly Rate for Non-ISO-Controlled Facilities x Interconnection Facilities Cost	[to be inserted after true-up]	[to be inserted after true-up]

\* Appendix X to the Transmission Owner Tariff is available at the following link:  
<https://www.sce.com/openaccess>

**18. Payment Schedule:**

The payment amounts shown below are based on an estimate of the monthly incurred costs for the Participating TO's Interconnection Facilities and Participating TO's Plan of Service Reliability Network Upgrades.

Payment No.	Payment Due Date	Interconnection Facilities Cost	Interconnection Facilities One-Time Cost	Plan of Service Reliability Network Upgrades Cost	Total Payment Amount	
	1*	PAID	\$3,533,477	\$189,724	\$2,600,000	\$6,323,201
	<b>Total</b>	<b>\$3,533,477</b>	<b>\$189,724</b>	<b>\$2,600,000</b>	<b>\$6,323,201</b>	

\*Note: Payment No. 1 above has been made by the Interconnection Customer via the cash deposits referenced in Appendix A, Section 10.b.1 that have been applied to the amounts due in accordance with Appendix A, Sections 10.b.3.

Interconnection Facilities Payment = (Interconnection Facilities Cost + associated One-Time Cost) = \$3,723,201

Distribution Upgrades Payment = (Distribution Upgrades Cost + associated One-Time Cost) = \$0

Reliability Network Upgrades Payment = (Reliability Network Upgrades Cost + associated One-Time Cost) = \$2,600,000. Reflects solely the costs of the Participating TO's Plan of Service Reliability Network Upgrades, since the Participating TO has agreed to finance the other Participating TO's Reliability Network Upgrades, subject to Appendix A, Section 14(d).

Delivery Network Upgrades Payment = (Delivery Network Upgrades Cost + associated One-Time Cost) = \$0 since the Participating TO has agreed to finance the Participating TO's Delivery Network Upgrades, subject to Appendix A, Section 14(d).

## Appendix B

### To First Amended LGIA

#### Milestones

**1. The Interconnection Customer's Selected Option:** Pursuant to Article 5.1 of the LGIA, the Interconnection Customer has selected the Standard Option.

#### 2. Milestone Dates :

<b><u>Item</u></b>	<b><u>Milestone</u></b>	<b><u>Responsible Party</u></b>	<b><u>Due Date</u></b>
(a)	Submit proof of insurance coverage in accordance with Article 18.3 of the LGIA	Interconnection Customer	This item has been completed
(b)	Submittal of written authorization to proceed with design and procurement of the Participating TO's Interconnection Facilities and Network Upgrades to the Participating TO and CAISO in accordance with Article 5.5.2 of the LGIA.	Interconnection Customer	This item has been completed
(c)	Submittal of second posting of Interconnection Financial Security for the Participating TO's Interconnection Facilities and Plan of Service Reliability Network Upgrades	Interconnection Customer	This item has been completed
(d)	Submittal of third posting of Interconnection Financial Security for the Participating TO's Interconnection Facilities and Plan of Service Reliability Network Upgrades	Interconnection Customer	This item has been completed
(e)	Submittal of written authorization to proceed	Interconnection Customer	This item has been completed

	with construction of the Participating TO's Interconnection Facilities and Network Upgrades to the Participating TO and the CAISO pursuant to Article 5.6.3 of the LGIA		
(f)	Submittal of security for the estimated tax liability to the Participating TO pursuant to Article 5.17.3 of the LGIA	Interconnection Customer	This item has been completed
(g)	Submittal of initial specifications for the Interconnection Customer's Interconnection Facilities and the Dracker Project, including System Protection Facilities, to the Participating TO and the CAISO pursuant to Article 5.10.1 of the LGIA	Interconnection Customer	This item has been completed for the First Sequence  At least one hundred eighty (180) Calendar Days prior to the Initial Synchronization Date for each of the remaining Electric Generating Units for the Second Sequence, as applicable
(h)	Review of and comment on the Interconnection Customer's initial specifications pursuant to Article 5.10.1 of the LGIA	Participating TO and CAISO	This has been completed for the First Sequence  Within thirty (30) Calendar Days of the Interconnection Customer's submission of initial specifications for each of the remaining Electric Generating Units for the Second Sequence, as applicable
(i)	Initial information submission which shall include the Participating TO's Transmission System information necessary to allow the Interconnection Customer	Participating TO	This item has been completed

	to select equipment, in accordance with Article 24.2 of the LGIA		
(j)	Submittal of final specifications for the Interconnection Customer's Interconnection Facilities and the Dracker Project, including System Protection Facilities, to the Participating TO and the CAISO pursuant to Article 5.10.1 of the LGIA	Interconnection Customer	This item has been completed for the initial Electric Generating Unit of the First Sequence  At least three (3) months prior to the Initial Synchronization Date for each of the remaining Electric Generating Units, as applicable
(k)	Review of and comment on the Interconnection Customer's final specifications pursuant to Article 5.10.1 of the LGIA	Participating TO and CAISO	This item has been completed for the initial Electric Generating Unit of the First Sequence  Within thirty (30) Calendar Days of the Interconnection Customer's submission of final specifications for each of the remaining Electric Generating Units, as applicable
(l)	Submittal of initial detailed PSCAD model of the Dracker Project and associated control systems, along with manufacturer contact information to facilitate the SSCI study in accordance with Section 8 of Appendix C	Interconnection Customer	This item has been completed
(m)	Updated information submission by the Interconnection Customer, including manufacturer information	Interconnection Customer	This item has been completed for the First Sequence. No later than one hundred eighty (180) Calendar



	in accordance with Article 24.3 of the LGIA		Days prior to Trial Operation for each Electric Generating Unit for the Second Sequence, as applicable
(n)	Submittal of final detailed PSCAD model of the Dracker Project and associated control systems, along with manufacturer contact information to facilitate the SSCI study in accordance with Section 8 of Appendix C	Interconnection Customer	This item has been completed
(o)	Notification of Balancing Authority Area to the Participating TO and CAISO pursuant to Article 9.2	Interconnection Customer	This item has been completed
(p)	Completion of the Participating TO's Interconnection Facilities, Interim WOD Project, and Network Upgrades	Participating TO	Interconnection Facilities: December 1, 2015*  Interim WOD Project: In Service  Reliability Network Upgrades: December 1, 2015*  Delivery Network Upgrades: August 1, 2021*
(q)	Performance of a complete calibration test and functional trip test of the System Protection Facilities pursuant to Article 9.7.4.6 of the LGIA	Interconnection Customer and Participating TO	Prior to the In-Service Date
(r)	In-Service Date	Interconnection Customer	This item has been completed
(s)	Testing of the Participating TO's Interconnection Facilities,	Interconnection Customer and Participating TO	Prior to the Initial Synchronization Date for each Electric

	Distribution Upgrades and Network Upgrades and testing of the Interconnection Customer's Interconnection Facilities and Dracker Project in accordance with Article 6.1 of the LGIA		Generating Unit for the First and Second Sequence
(t)	Provide written approval to the Interconnection Customer for the operation of the Dracker Project in accordance with Article 6.1 of the LGIA	Participating TO	At least ten (10) Calendar Days prior to the Initial Synchronization Date for each Electric Generating Unit for the First and Second Sequence
(u)	Provide the CAISO written notice that the required Participating TO facilities have been installed and tested, and that initial synchronization of the Electric Generating Unit(s) at the Dracker Project to the CAISO Controlled Grid is expected to occur on the Initial Synchronization Date	Participating TO	At least ten (10) Calendar Days prior to the Initial Synchronization Date for each Electric Generating Unit for the First and Second Sequence
(v)	Initial Synchronization Date	Interconnection Customer	Initial Electric Generating Unit for the First Sequence: December 15, 2015  Second Electric Generating Unit for the First Sequence: May 1, 2016  Initial Electric Generating Unit for the Second Sequence: December 1, 2019

			Second Electric Generating Unit for the Second Sequence: June 1, 2020
(w)	Provide the CAISO written notice that the required Participating TO facilities have been installed and tested, and have been approved to allow the Dracker Project to operate in parallel with the CAISO Controlled Grid	Participating TO	Within five (5) Calendar Days after the Initial Synchronization Date and satisfaction of the testing requirements of Articles 6.1 and 9.7.4.6 of the LGIA
(x)	Commercial Operation Date	Interconnection Customer	Initial Electric Generating Unit for the First Sequence: May 30, 2016  Second Electric Generating Unit for the First Sequence: November 1, 2016  Third Electric Generating Unit for the Second Sequence: June 1, 2020 Fourth Electric Generating Unit for the Second Sequence: December 1, 2020
(y)	Submittal to the Participating TO and the CAISO of "as-built" drawings, information and documents for the Interconnection Customer's Interconnection Facilities and Electric Generating Units, in accordance with Articles 5.10.3 of the LGIA	Interconnection Customer	Within one hundred twenty (120) Calendar Days after the Commercial Operation Date for the first Electric Generating Unit, unless otherwise agreed, and within one hundred twenty (120) Calendar Days after the Commercial Operation Date for each of the remaining Electric Generating

			Units
--	--	--	-------

\* **Note:** The Interconnection Customer understands and acknowledges that such timeline is only an estimate and that equipment and material lead times, labor availability, outage coordination, regulatory approvals, right-of-way negotiations, or other unforeseen events could delay the actual in-service dates of the Participating TO's Interconnection Facilities, Distribution Upgrades, or Network Upgrades beyond those specified. The Participating TO shall not be liable for any cost or damage incurred by the Interconnection Customer because of any delay in the work provided for in this LGIA.

## Appendix C

### To First Amended LGIA

#### Interconnection Details

1. The Generating Facility includes, but is not limited to, all equipment and facilities comprising the proposed generating facility, shown in the figure below, located near Blythe, California, as disclosed by the Interconnection Customer in its Interconnection Request, dated January 15, 2008, as modified with CAISO and Participating TO approval via Interconnection Customer's letter dated December 31, 2012; and as amended on January 2, 2013 during the CAISO One-Time Interconnecting Generator Downsizing Opportunity; and as further modified with CAISO and Participating TO approval via Interconnection Customer's letter dated December 1, 2015. The Generating Facility consists of seventy-two (72) GE 4.0 MVA inverters, one-hundred and fourteen (114) GE 2.0 MVA inverters, fourteen (14) GE 1.4 MVA inverters, one (1) GE 1.0 MVA inverter, six (6) SMA 1.85 inverters, two (2) SMA 0.5 MVA inverters, 209 padmount transformers, four (4) 230/34.5/13.8kV 140MVA main step-up transformers with 9% impedance on a 84 MVA base, meters and metering equipment, and appurtenant equipment distributed among the Generating Facility as follows: **UNIT 1** – fifty-four (54) GE 2.0 MVA, six (6) GE 1.4 MVA, three (3) SMA 1.85 MVA, and two (2) SMA 0.5 MVA inverters with 65 padmount transformers for a total rated output of 116.46 MW at the inverter terminals; **UNIT 2** – sixty (60) GE 2.0 MVA, eight (8) GE 1.4 MVA, one (1) GE 1.0 MVA, and three (3) SMA 1.85 MVA inverters with 72 padmount transformers for a total rated output of 131.18 MW at the inverter terminals; **UNIT 3** – thirty-six (36) GE 4.0 MVA inverters with 36 padmount transformers for a total rated output of 136.8 MW at the inverter terminals; and **UNIT 4** – thirty six (36) GE 4 MVA inverters with 36 padmount transformers for a total rated output of 136.8 MW at the inverter terminals (together the "Dracker Project" or the "Generating Facility"). The Generating Facility combined gross rated output at the inverter terminals is 521.2 MW. Based on the electrical parameters provided by the Interconnection Customer, the Generating Facility auxiliary load is 2.4 MW and losses through the internal collector system are approximately 4.3 MW, resulting in a net output of 514.5 MW as measured at the high-side of the main step-up transformers at the Generating Facility. In accordance with Section 3.b. of this Appendix C, the Interconnection Customer is required to install a control limiting device at the Generating Facility to ensure that the net output does not exceed 487 MW at the high-side of the main step-up transformers at the Generating Facility. Capacity at the Point of Interconnection for Interconnection Service is 485 MW after accounting for approximately 2.0 MW of losses on the Colorado River-Dracker 220kV Transmission Line.

# Dracker Project - Q294/TOT276

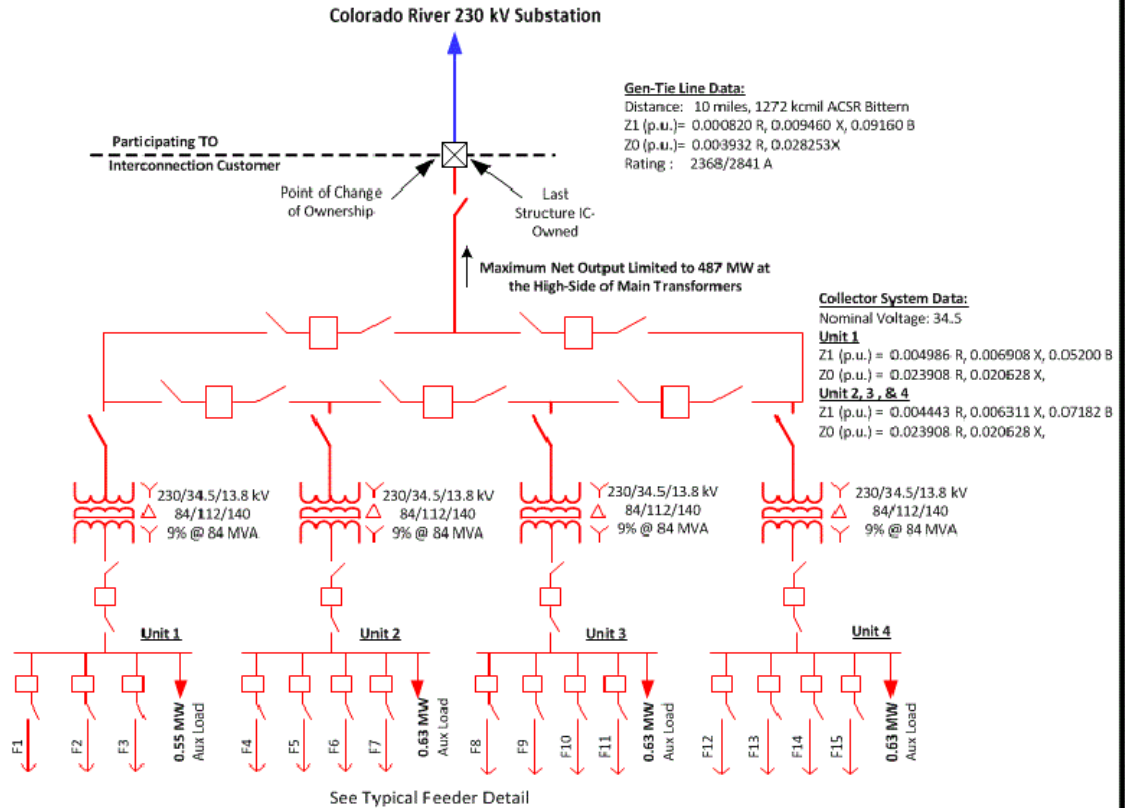

## FACILITY DESCRIPTION

Note:  
For detailed inverter information reference Gen Module Detail

### Unit 1 contains 65 Inverters

#### Feeders 1-3 contains:

- 54 GE 2 MVA (GM4-a) inverters with 54 Padmount XFMRs (102.6 MW)
  - 6 GE 1.4 MVA (GM5) inverters with 6 Padmount XFMRs (8.4 MW)
  - 3 SMA 1.85 MVA (GM1-a,b,c) inverters with 3 Padmount XFMRs (4.46 MW)
  - 2 SMA 0.5 MVA (GM2) inverters with 2 Padmount XFMRs (1 MW)
- Total Output: 116.46 MW**

### Unit 2 contains 72 Inverters

#### Feeders 4-7 contains:

- 60 GE 2 MVA (GM4-a) inverters with 60 Padmount XFMRs (114 MW)
  - 8 GE 1.4 MVA (GM5) inverters with 8 Padmount XFMRs (11.2 MW)
  - 1 GE 1 MVA (GM4-b) inverter with 1 Padmount XFMRs (1 MW)
  - 3 SMA 1.85 MVA (GM1-a) inverters with 3 Padmount XFMRs (4.98 MW)
- Total Output: 131.18 MW**

### Unit 3 contains 36 Inverters

#### Feeders 8-11 contains:

- 36 GE 4 MVA (GM3) inverters with 36 Padmount XFMRs (136.8 MW)

### Unit 4 contains 36 Inverters

#### Feeders 12-15 contains:

- 36 GE 4 MVA (GM3) inverters with 36 Padmount XFMRs (136.8 MW)

## TYPICAL FEEDER DETAIL

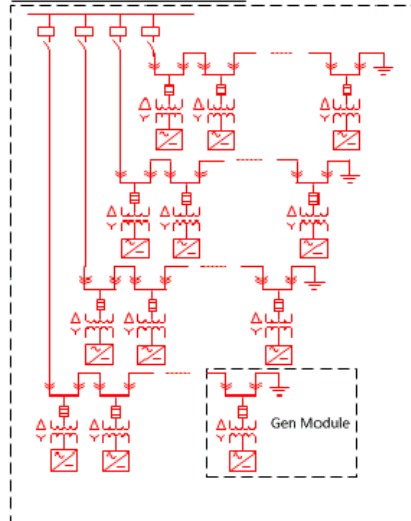





## Dracker Project - Q294/TOT276

### GENERAL NOTES

Note: The Power Plant Controller will limit the maximum output of the generation facility to 487 MW at the high side of the GSU  
 Note: All generators are Solar PV

### GEN MODULE DETAIL

<p><b>GM1</b></p>	<p><b>GEN MODULE 1 - SMA 1.85 MVA</b></p> <p><b>GEN MODULE 1 - a</b> QTY: 4 Individual Generator Output: <b>1.66 MW</b></p> <p><b>GEN MODULE 1 - b</b> QTY: 1 Individual Generator Output: <b>1.50 MW</b></p> <p><b>GEN MODULE 1 - c</b> QTY: 1 Individual Generator Output: <b>1.30 MW</b></p> <p>Rated MVA: 1.85 MVA PF: 0.95 Rated Voltage: 0.270 kV Max SCD Contribution: <b>2.2 p.u.</b></p>	<p><b>Padmount XFMR</b> Rated Voltage: 34.5/0.27 kV Rated MVA: 1.85/1.85 MVA Impedance: 6% @1.85 MVA H Winding: Delta X Winding: Wye</p>	<p style="text-align: center;"><b>Module Detail</b></p> 
<p><b>GM2</b></p>	<p><b>GEN MODULE 2 - SMA 0.5 MVA</b> QTY: 2</p> <p>Individual Generator Output: <b>0.5 MW</b> Rated MVA: 0.5 MVA PF: 1.0 Rated Voltage: 0.270 kV Max SCD Contribution: <b>2.2 p.u.</b></p>	<p><b>Padmount XFMR</b> Rated Voltage: 34.5/0.27 kV Rated MVA: 0.5/0.5 MVA Impedance: 6% @0.5 MVA H Winding: Delta X Winding: Wye</p>	<p style="text-align: center;"><b>Module Detail</b></p> 
<p><b>GM3</b></p>	<p><b>GEN MODULE 3 - GE 4 MVA</b> QTY: 72</p> <p>Individual Generator Output: <b>3.8 MW</b> Rated MVA: 4.0 MVA PF: 0.95 Rated Voltage: 0.55 kV Max SCD Contribution: <b>1.3 p.u.</b></p>	<p><b>Padmount XFMR</b> Rated Voltage: 34.5/0.55 kV Rated MVA: 4.0/4.0 MVA Impedance: 6.97% @ 4.0 MVA H Winding: Delta X Winding: Wye</p>	<p style="text-align: center;"><b>Module Detail</b></p> 
<p><b>GM4</b></p>	<p><b>GEN MODULE 4 - GE 2 MVA</b></p> <p><b>GEN MODULE 4 - a</b> QTY: 114 Individual Generator Output: <b>1.9 MW</b> Rated MVA: 2.0 MVA PF: 0.95 Rated Voltage: 0.55 kV Note: The inverter consists of one 0.95 MW inverter in each of the two LV windings</p> <p><b>GEN MODULE 4 - b - GE 1 MVA</b> QTY: 1 Individual Generator Output: <b>1.0 MW</b> Rated MVA: 1.0 MVA PF: 1.0 Rated Voltage: 0.55 kV <sup>1</sup>Note: Only one LV winding will be used for this generator in Plant 2 Max SCD Contribution: <b>1.3 p.u.</b></p>	<p><b>Padmount XFMR</b> Rated Voltage: 34.5/0.55/0.55 kV Rated MVA: 2/1/1 MVA Impedance: H-X 6.3% @2 MVA H-Y 6.33% @1 MVA X-Y 14.16% @1MVA H Winding: <b>Delta</b> X Winding: <b>Wye GND</b> Y Winding: <b>Wye GND</b></p>	<p style="text-align: center;"><b>Module Detail</b></p> 
<p><b>GM5</b></p>	<p><b>GEN MODULE 5 - GE 1.4 MVA</b> QTY: 14</p> <p>Individual Generator Output: <b>1.4 MW</b> Rated MVA: 1.4 MVA PF: 1.0 Rated Voltage: 0.48 kV Note: The inverter consists of one 0.70 MW inverter in each of the two LV windings Max SCD Contribution: <b>1.3 p.u.</b></p>	<p><b>Padmount XFMR</b> Rated Voltage: 34.5/0.48/0.277 kV Rated MVA: 1.5/0.75/0.75 MVA Impedance: H-X 5.5% @1.5 MVA H-Y 5.5% @0.75 MVA X-Y 8.1% @0.75 MVA H Winding: <b>Delta</b> X Winding: <b>Wye</b> Y Winding: <b>Wye</b></p>	<p style="text-align: center;"><b>Module Detail</b></p> 

## **2. Interconnection Customer Operational Requirements.**

- a. Pursuant to Article 9.4 of the LGIA, the Interconnection Customer shall operate the Dracker Project and the Interconnection Customer's Interconnection Facilities in accordance with the CAISO Tariff, NERC and the Applicable Reliability Council requirements, and Applicable Reliability Standards.
- b. The Dracker Project shall be operated so as to prevent or protect against the following adverse conditions on the Participating TO's electric system: inadvertent and unwanted re-energizing of a utility dead line or bus; interconnection while out of synchronization; overcurrent; voltage imbalance; ground faults; generated alternating current frequency outside permitted safe limits; power factor or reactive power outside permitted limits; and abnormal waveforms.

## **3. Interconnection Principles:**

- a. This LGIA provides for interconnection of the Dracker Project in the amount of 485 MW at the Point of Interconnection, as described in Section 1 of this Appendix C. The Interconnection Customer acknowledges that if the Interconnection Customer wishes to increase the amount of interconnection capacity provided pursuant to this LGIA, the Interconnection Customer shall be required to submit a new Interconnection Request in accordance with the terms and conditions of the CAISO Tariff.
- b. The Parties acknowledge that the Dracker Project has a maximum net output (installed gross MW less auxiliary load and internal collector system losses) that exceeds the capacity allotted the Dracker Project under this LGIA. Accordingly, the Interconnection Customer agrees to install, own, operate and maintain a control limiting device that will restrict the maximum net output of the Dracker Project to no greater than 487 MW, as measured at the high side of the main step-up transformers at the Generating Facility.
  - (i) The Interconnection Customer's control limiting device for the Dracker Project shall be reviewed and approved by the Participating TO and the CAISO and installed prior to the Dracker Project Initial Synchronization Date.
  - (ii) The control limiting device must be tested and remain in-service and operable at all times during which the Dracker Project is producing electricity.
  - (iii) The Interconnection Customer understands and acknowledges that if at any time the Participating TO or CAISO identifies that the Dracker Project has exceeded its allotted 487 MW output (as measured at the high side of the main step-up transformers at the



Generating Facility), then the Participating TO, with one (1) Calendar Day prior written notice, may open the Colorado River-Dracker 220kV Transmission Line circuit breaker at Colorado River Substation to temporarily disconnect the Dracker Project from the CAISO Controlled Grid, until such time as the Interconnection Customer can demonstrate, to the satisfaction of the Participating TO and the CAISO, that the Dracker Project is, again, capable of being restricted to within the allotted 487 MW by the Interconnection Customer's control limiting device.

Nothing in this Section 3.b. shall be construed by the Interconnection Customer in any way to limit the Participating TO's or the CAISO's authority and ability to take whatever corrective actions they deem necessary during an Emergency Condition in accordance with Article 13.5 of this LGIA.

- c. The costs associated with any mitigation measures required to third party transmission systems resulting from the interconnection of the Dracker Project to the Participating TO's electrical system are not reflected in this LGIA. The Participating TO shall have no responsibility to pay costs associated with any such mitigation measures. If applicable, Interconnection Customer shall enter into an agreement with such third parties to address any required mitigation in accordance with Section 12.4 of the LGIP.
- d. In the event the Participating TO's Interconnection Facilities are utilized to provide retail service to the Interconnection Customer in addition to the wholesale Interconnection service provided herein, and the Interconnection Customer fails to make payment for such retail service in accordance with the Participating TO's applicable retail tariffs, the Participating TO's Interconnection Facilities may be removed from service to the Interconnection Customer, subject to the notice and cure provisions of such retail tariffs, until payment is made by the Interconnection Customer pursuant to such retail tariffs.
- e. Review by the Participating TO of the electrical specifications, design, construction, operation, or maintenance of the Dracker Project or the Interconnection Customer's Interconnection Facilities shall not constitute any representation as to the economic or technical feasibility, operational capability, or reliability of such facilities. The Interconnection Customer shall in no way represent to any third party that any such review by the Participating TO of such facilities, including, but not limited to, any review of the design, construction, operation, or maintenance of such facilities by the Participating TO, is a representation by the Participating TO as to the economic or technical feasibility, operational capability, or reliability of the Dracker Project or the Interconnection Customer's Interconnection Facilities.

- f. The Interconnection Customer shall complete and receive approval for all environmental impact studies and any permitting necessary for the construction, operation and maintenance of the Dracker Project. The Interconnection Customer shall include Participating TO's Interconnection Facilities, Distribution Upgrades and Participating TO's Reliability Network Upgrades described in Appendix A of this LGIA in all such environmental impact studies, where applicable. The Interconnection Customer shall provide the results of such studies and approvals to Participating TO for use in Participating TO's application(s) to obtain the regulatory approvals required to be obtained by Participating TO for the construction, operation, and maintenance of the Participating TO's Interconnection Facilities, Distribution Upgrades and Reliability Network Upgrades described in Appendix A of this LGIA.
- g. The Interconnection Customer is responsible for all costs associated with any necessary relocation of any Participating TO facilities as a result of the Dracker Project and acquiring all property rights necessary for the Interconnection Customer's Interconnection Facilities, including those required to cross the Participating TO's facilities and property. The relocation of Participating TO facilities or use of Participating TO property rights shall only be permitted upon written agreement between Participating TO and the Interconnection Customer. Any proposed relocation of Participating TO facilities or use of Participating TO property rights may require a study and/or evaluation, the cost of which would be borne by the Interconnection Customer, to determine whether such use may be accommodated. The terms and conditions of any such use of Participating TO facilities or property rights would be the subject of a separate agreement and any associated costs to the Interconnection Customer would not be considered a Network Upgrade and would not be refundable to the Interconnection Customer, pursuant to Article 11.4 of this LGIA.
- h. This LGIA does not address any requirements for standby power or temporary construction power that the Dracker Project may require prior to the in-service date of the Interconnection Facilities. Should the Dracker Project require standby power or temporary construction power from Participating TO prior to the actual In-Service Date of the Interconnection Facilities, the Interconnection Customer is responsible to make appropriate arrangements with Participating TO to receive and pay for such retail service.

#### **4. Cluster Study Group:**

- a. The Dracker Project participated in the CAISO's Eastern Bulk System Cluster for purposes of assessing impacts to the Participating TO's electrical system and that portion of the Participating TO's electrical system that constitutes the CAISO Controlled Grid.

#### **5. Interconnection Operations:**

- a. The Interconnection Customer shall cause the Dracker Project to participate in any SPS required to prevent thermal overloads and unstable conditions resulting from outages. Such participation shall be in accordance with applicable FERC regulations, and the CAISO Tariff. The Interconnection Customer will not be entitled to any compensation from the Participating TO, pursuant to the LGIA, for loss of generation output when (i) the Dracker Project generation is reduced or tripped off-line due to implementation of the SPS; or (ii) such generation output is restricted in the event the SPS becomes inoperable. Pursuant to Good Utility Practice, the Participating TO will provide the Interconnection Customer advance notice of any required SPS beyond that which has already been identified in the Phase II Interconnection Study, the Interim WOD Project operational study report dated November 17, 2011, and this LGIA.
- b. The Interconnection Customer shall cause the Dracker Project to participate in CAISO congestion management in accordance with the CAISO Tariff. This may result in limiting the output of the Generating Facility in the CAISO markets. The Generating Facility's deliverability status does not affect how the resource is scheduled, dispatched, or curtailed in the CAISO's markets.
- c. Following outages of the Interconnection Facilities or the Dracker Project, the Interconnection Customer shall not energize the Dracker Project for any reason without specific permission from the Participating TO's and the CAISO's operations personnel. Such permission shall not be unreasonably withheld.
- d. The Interconnection Customer shall maintain operating communications with the Participating TO's designated switching center. The operating communications shall include, but not be limited to, system parallel operation or separation, scheduled and unscheduled outages, equipment clearances, protective relay operations, and levels of operating voltage and reactive power.
- e. The Interconnection Customer has elected for the Dracker Project to have Full Capacity Deliverability Status as such term is defined in the

CAISO Tariff. Subject to the sequencing described in Appendix A, Interconnection Customer acknowledges and understands that, until the Participating TO's Delivery Network Upgrades are constructed and placed in service, the Dracker Project will not achieve Full Capacity Deliverability Status unless, as determined by the CAISO, Full Capacity Deliverability Status otherwise becomes available and is allocated to the Dracker Project. The Interim WOD Project, and Interconnection Customer's election to participate therein, temporarily substitutes for the Participating TO's Delivery Network Upgrades (namely the West of Devers Upgrades) described in this Appendix A, Section 2.b.ii.1 until such upgrades are completed and placed in service.

- f. Subsequent to the execution of this LGIA, on May 22, 2013, in accordance with the "Procedures to Exercise Option Rights for Interim West of Devers Project" dated April 2, 2013, as such procedures were developed by the Participating TO and the CAISO, Interconnection Customer provided written notification to the Participating TO and the CAISO of its election for the Dracker Project to participate in the Interim West of Devers Project. The Interconnection Customer's option to participate in the Interim West of Devers Project is described in CAISO's letter to FERC dated December 23, 2011 under the subject "Interim West of Devers Project Beneficiaries" as filed in FERC Docket Number ER12-804. The Interim West of Devers Project enables the Dracker Project, and certain other generating facilities, including the generating facility having CAISO Queue No. 193, to attain Full Capacity Deliverability Status for an interim period until the Participating TO's Delivery Network Upgrades can be constructed and placed in service.
- g. In its role as the entity responsible for the engineering and design of Participating TO's Interconnection Facilities and Network Upgrades, the Participating TO may perform technical assessments reasonably required to assess the impact of changed circumstances that occur after the execution of the LGIA on the scope of service and/or continuing need for Participating TO's Interconnection Facilities and Network Upgrades identified for the Dracker Project, as set forth in Appendix A of this LGIA. Such technical assessments may be requested by any of the Parties to this LGIA. The CAISO and Participating TO shall coordinate efforts on the technical assessments and in particular avoid duplicative assessment efforts with respect to Network Upgrades that are currently being evaluated as part of the CAISO's annual reassessment, as set forth in Section 7.4 of Appendix DD to the CAISO Tariff. The CAISO and Participating TO shall coordinate in reviewing the results of any technical assessments. The results of an approved technical assessment shall be used as the

basis for amending this LGIA in accordance with the amendment provisions in this LGIA.

The Interconnection Customer shall provide the CAISO a \$10,000 deposit for the technical assessment. The Interconnection Customer shall be responsible for the actual costs incurred by the CAISO and Participating TO for the conduct of the technical assessment. If the actual costs of the technical assessment are less than the deposit provided by the Interconnection Customer, the Interconnection Customer will be refunded the balance according to the timeline for refunds set forth in Section 6.7.2.3 of Appendix DD to the CAISO Tariff. If the actual costs of the technical assessment are greater than the deposit provided by the Interconnection Customer, the Interconnection Customer shall pay the balance when invoiced.

- 6. Compliance with Applicable Reliability Standards:** The Interconnection Customer shall comply with all Applicable Reliability Standards for its Interconnection Customer's Interconnection Facilities and the Dracker Project. The Participating TO will not assume any responsibility for complying with mandatory reliability standards for such facilities and offers no opinion whether the Interconnection Customer must register with NERC. If required to register with NERC, the Interconnection Customer shall be responsible for complying with all Applicable Reliability Standards for its Interconnection Customer's Interconnection Facilities up to the Point of Change of Ownership as described in Appendix A, Section 5.
- 7. Affected Systems Coordination:** The CAISO cannot study comprehensively the impacts of the Generating Facility on the transmission systems of Affected System operators. The CAISO does not have detailed information about Affected Systems on a transmission-element level, nor does the CAISO know the details of the various reliability and operating criteria applicable to the Affected Systems. In addition, because the operation of transmission systems and NERC reliability standards change over time, the CAISO cannot presume to know all of the impacts of these changes on Affected Systems. As such, the CAISO contacted all Potentially Affected Systems to inquire whether they are impacted by the Generating Facility's interconnection to the CAISO Controlled Grid. The CAISO provided notice to the Interconnection Customer of the Identified Affected Systems for the Generating Facility. To ensure a safe and reliable interconnection to the CAISO Controlled Grid, prior to the Initial Synchronization Date of the Generating Facility, the Interconnection Customer shall provide documentation to the CAISO, in accordance with Article 11.4.2 of the LGIA, confirming that the Identified Affected Systems have been contacted by the Interconnection Customer, and (i) that any system reliability impacts have been addressed (or that there are no system impacts), or (ii) that the Interconnection Customer has taken all reasonable steps to address potential

reliability system impacts with the Identified Affected Systems but has been unsuccessful.

- 8. Subsynchronous Interaction Studies:** Certain generators are susceptible to sub-synchronous control interaction (SSCI) when interconnected within electrical proximity of series capacitor banks on the transmission system. In order to evaluate the SSCI between generating facilities with inverter-based generation technology and the transmission system, a study will need to be performed. The study will require that the Interconnection Customer provide a detailed PSCAD model of its Generating Facility and associated control systems, along with the manufacturer representative's contact information. The study will identify any mitigation(s) that will be required prior to initial synchronization of the Generating Facility. The study and the proposed mitigation(s) shall be at the expense of the Interconnection Customer.
  
- 9. Interconnection Customer Ownership Structure:** The Parties acknowledge and agree that the Interconnection Customer may elect to structure the legal ownership of the entire Generating Facility referenced in this LGIA, known as the Dracker Project, in order to divide its ownership into three, or four, separate legal entity owners so long as each such owner is an Affiliate of one another and each owns one or more discrete Electric Generating Unit(s) and other physical components of the entire Generating Facility in a manner that is consistent with the "Recitals to Appendix A". Each of these Affiliates shall be an owner of the Interconnection Customer and, in no event, shall such Affiliate's percentage ownership be less than 25% of the Interconnection Customer. The Parties further acknowledge and agree that:
  - i. the ownership structure of the Dracker Project shall be detailed in the Interconnection Customer's Operating Agreement ("Operating Agreement") that shall contain the terms and conditions listed below in subsections (a) through (c) and which shall be subject to the review and reasonable approval of the Participating TO and the CAISO; and
  - ii. each of the Affiliate owners of the Interconnection Customer shall be required to have executed a joinder agreement by which each Affiliate owner agrees to both (1) be bound by and subject to the obligations and responsibilities of the Interconnection Customer under this LGIA and (2) assume joint and several liability for such obligations and responsibilities, as if each Affiliate owner were a party to the LGIA (such agreement to be referred to herein as the "Joinder Agreement").

The Joinder Agreement shall be in a form subject to review and reasonable approval of the CAISO and the Participating TO.

- a) The division of Affiliate ownership in the Generating Facility shall not exceed the number of phases or Electric Generating Units designated by the Interconnection Customer for purposes of Partial Termination.

b) The Interconnection Customer shall serve as agent for its Affiliate owners who receive the benefits of the Interconnection Customer's rights under this LGIA; however, the Interconnection Customer's Affiliate owners are not parties to this LGIA and such benefits shall be derived solely by and through the Interconnection Customer. The Interconnection Customer's Affiliate owners shall receive any benefits of the Interconnection Customer's rights only to the extent of those Interconnection Customer's rights are provided for under this LGIA. Additionally, such benefits shall exist only for such period of time as the Interconnection Customer is a Party to this LGIA. Notwithstanding any provision to the contrary in the anticipated Dracker Project Operating Agreement, no provision in either that Operating Agreement or this LGIA shall operate or be construed so as to:

- i. relieve the Interconnection Customer of its obligations to the Participating TO or the CAISO under this LGIA;
- ii. require either the Participating TO or the CAISO to communicate directly with, or look to, the Interconnection Customer's Affiliate owners with respect to the Interconnection Customer's performance under this LGIA;
- iii. entitle any of the Interconnection Customer's Affiliate owners to receive any notice under the LGIA from the Participating TO or the CAISO; or,
- iv. provide any rights or benefits under the LGIA to the Interconnection Customer's Affiliate owners other than by or through the Interconnection Customer, as provided in and as limited by this paragraph.

c) The Operating Agreement shall require the Interconnection Customer to communicate with its Affiliate owners in order to ensure that all requirements of this LGIA are performed by the Interconnection Customer. The Operating Agreement shall further require that each of the Interconnection Customer's Affiliate owners comply with the Interconnection Customer's instructions, in order to ensure that the Interconnection Customer complies with the provisions of this LGIA. No failure by any of the Interconnection Customer's Affiliate owners to comply with any instructions from the Interconnection Customer shall excuse the Interconnection Customer from performance of any of its obligations under this LGIA. The Operating Agreement and the Joinder Agreement shall each provide that each Affiliate owner shall have and maintain a credit rating that is equal to or greater than the credit rating of that the Interconnection Customer had as of execution of this LGIA and that each owner has both the legal authority and the operational abilities to satisfy the obligations of this LGIA. The Operating Agreement and the Joinder Agreement shall each further provide that the Interconnection Customer's Affiliate owners shall be jointly and severally liable to the

Participating TO and CAISO for any obligations and liabilities of the Interconnection Customer arising out of this LGIA.

- d) The Interconnection Customer and each of its Affiliate owners shall agree in the Operating Agreement not to assign any claims of benefit, under that Operating Agreement, to any third party. However, each of the Interconnection Customer's Affiliate owners shall have the right to assign for collateral security purposes, for financing of the Dracker Project, any of that Affiliate owner's respective rights and obligations under the Operating Agreement.



**Appendix D**  
**To First Amended LGIA**  
**Security Arrangements Details**

Infrastructure security of CAISO Controlled Grid equipment and operations and control hardware and software is essential to ensure day-to-day CAISO Controlled Grid reliability and operational security. FERC will expect the CAISO, all Participating TOs, market participants, and Interconnection Customers interconnected to the CAISO Controlled Grid to comply with the recommendations offered by the President's Critical Infrastructure Protection Board and, eventually, best practice recommendations from the electric reliability authority. All public utilities will be expected to meet basic standards for system infrastructure and operational security, including physical, operational, and cyber-security practices.

The Interconnection Customer shall meet the requirements for security implemented pursuant to the CAISO Tariff, including the CAISO's standards for information security posted on the CAISO's internet web site at the following internet address: <http://www.caiso.com/pubinfo/info-security/index.html>.

## Appendix E

### To First Amended LGIA

#### Commercial Operation Dates

[This Appendix E sets forth a form of letter to be provided by the Interconnection Customer to the CAISO and Participating TO to provide formal notice of the Commercial Operation of an Electric Generating Unit. The Interconnection Customer shall send separate such letters for the First Sequence and for the Second Sequence.]

**[Date]**

Mr. Mike Turner  
Manager, Model and Contract Implementation  
California Independent System Operator Corporation  
250 Outcropping Way  
Folsom, CA 95630

Mr. William Law  
Manager, Grid Contracts Management  
Southern California Edison Company  
P. O. Box 800  
2244 Walnut Grove Avenue  
Rosemead, California 91770

Re: NextEra Blythe Solar Energy Center, LLC-Dracker Project Electric  
Generating Unit

Dear Messrs. Turner, and Law:

On **[Date]** NextEra Blythe Solar Energy Center, LLC has completed Trial Operation of Dracker Project Unit No. \_\_\_\_\_. This letter confirms that NextEra Blythe Solar Energy Center, LLC commenced Commercial Operation of Dracker Project Unit No. \_\_\_\_ at the Electric Generating Unit, effective as of **[Date plus one day]** and that NextEra Blythe Solar Energy Center, LLC provided the CAISO's operations personnel advance notice of its intended Commercial Operation Date no less than five Business Days prior to that date.

Thank you.

**[Signature]**

**[Interconnection Customer Representative]**

cc: Queue Management, CAISO

## Appendix F

### To First Amended LGIA

#### Addresses for Delivery of Notices and Billings

**Notices:**

**1. General Notices:**

CAISO	Participating TO	Interconnection Customer
Regulatory Contracts 250 Outcropping Way Folsom, CA 95630	Manager, Grid Contracts Management P. O. Box 800 Rosemead, CA 91770	NextEra Blythe Solar Energy Center, LLC Andrew Kushner Vice President, Business Management 700 Universe Blvd. June Beach, FL 33408

**2. Operating Communications and Notifications:**

The CAISO, Participating TO and the Interconnection Customer shall provide for operating communications through their respective designated representatives as follows:

The Parties agree to exchange the following information ten (10) Calendar Days prior to the Initial Synchronization Date.

CAISO	Participating TO (Southern California Edison Company)	Interconnection Customer NextEra Blythe Solar Energy Center, LLC
CAISO Real Time Desk/24 Hour Telephone:	Grid Control Center/24 Hour Telephone:	*Operator Name and/or Title: Control Room Operator *24 Hour Telephone:
Alternate Phone:		*Operation Center Fax. No.: *E-mail:

**3. Operational Matters, Force Majeure, and Outage Notices:**

CAISO	Participating TO	Interconnection Customer
Name: Phone:	Name/Title: Phone:	NextEra Blythe Solar Energy Center, LLC Attn: Andrew Kushner Vice President, Business Management 700 Universe Blvd. Juno Beach, FL 33408 Phone:

**4. For Emergencies:**

CAISO	Participating TO	Interconnection Customer
Name: Phone:	Name/Title: Phone:	NextEra Blythe Solar Energy Center, LLC Attn: Phone:

**5. Billing and Payments:**

CAISO	Participating TO	Interconnection Customer
Finance Dept. Mr. Dennis Estrada 250 Outcropping Way Folsom, CA 95630	Accounts Receivable (GCM) P. O. Box 800 Rosemead, CA 91770	NextEra Blythe Solar Energy Center, LLC Jennifer Dudek Director, Business Management 700 Universe Blvd. Juno Beach, FL 33408 Phone:

**6. Alternate Forms of Delivery of Notices (telephone, facsimile or e-mail):**

CAISO	Participating TO	Interconnection Customer
Queue Management 250 Outcropping Way Folsom, CA 95630 queuemanagement@caiso.com	Manager, Grid Contracts Management Tel: (626) 302-9640 Fax: (626) 302-1152	NextEra Blythe Solar Energy Center, LLC Jennifer Dudek Director, Business Management Phone: 561-304-5383 Jennifer.Dudek@nee.com

## Appendix G

### To First Amended LGIA

#### Interconnection Customer's Proportional Share of Costs of Network Upgrades for Applicable Project Group

\*The \$\$ amount listed in the following table are in 2010 dollars as provided in the Phase II Interconnection Facilities Report

Type	Upgrades	Needed For	Cost factor	Cost Share* (\$1000)
Delivery	West of Devers 220kV upgrades: Reconductoring four 230kV lines of West of Devers.	Normal and contingency overload	42.70%	\$163,748
Delivery	Expand Colorado River (CR) Substation: add the second 500/220 AA transformer banks, rated at 1120 MVA as normal rating.	Normal overload on the first Colorado River 500/230 kV transformer	60.61%	\$25,480
Reliability	Expand Colorado River (CR) Substation: Build CR 500/220 kV Substation with a new 500/220 AA transformer banks, rated at 1120 MVA as normal rating.	Interconnect the new generators at Colorado River 230 kV bus	60.61%	\$34,382
Reliability	Loop-in the Red Bluff (RB) 500/220 kV Substation into the Colorado - Devers 500 kV #2 line	To balance power flow on DPV 1 and DPV 2 lines	46.51%	\$15,017
Reliability	Replace the line raiser on Mira Loma – Vista 220 kV #2 line to 3500amps or higher	Emergency overload in off-peak reliability study	45.46%	\$48
Reliability	Develop a SPS to trip 1400MW TC2 generation to mitigate dynamic voltage violations under the N-2 of Devers – RedBluff No.1 and No.2 500 kV lines.	Dynamic voltage violation under N-2 contingency	46.51%	\$345
Reliability	Develop a SPS to trip 500 MW TC2 generation at the Colorado River 500/220 kV substation to mitigate the overload by on one AA bank for the loss of another AA bank (T-1 contingency)	Emergency overload	60.61%	\$2,115
Plan of Service Reliability Network Upgrade	Substation, Power System Control	Direct Assigned Network upgrades needed to enable interconnection.	100.00%	\$4,306
			Total:	\$245,441

## **Appendix H**

### **To First Amended LGIA**

#### **INTERCONNECTION REQUIREMENTS FOR AN ASYNCHRONOUS GENERATING FACILITY**

Appendix H sets forth interconnection requirements specific to all Asynchronous Generating Facilities. Existing individual generating units of an Asynchronous Generating Facility that are, or have been, interconnected to the CAISO Controlled Grid at the same location are exempt from the requirements of this Appendix H for the remaining life of the existing generating unit. Generating units that are replaced, however, shall meet the requirements of this Appendix H.

#### **A. Technical Requirements Applicable to Asynchronous Generating Facilities**

##### **i. Low Voltage Ride-Through (LVRT) Capability**

An Asynchronous Generating Facility shall be able to remain online during voltage disturbances up to the time periods and associated voltage levels set forth in the requirements below.

1. An Asynchronous Generating Facility shall remain online for the voltage disturbance caused by any fault on the transmission grid, or within the Asynchronous Generating Facility between the Point of Interconnection and the high voltage terminals of the Asynchronous Generating Facility's step up transformer, having a duration equal to the lesser of the normal three-phase fault clearing time (4-9 cycles) or one-hundred fifty (150) milliseconds, plus any subsequent post-fault voltage recovery to the final steady-state post-fault voltage unless clearing the fault effectively disconnects the generator from the system. Clearing time shall be based on the maximum normal clearing time associated with any three-phase fault location that reduces the voltage at the Asynchronous Generating Facility's Point of Interconnection to 0.2 per-unit of nominal voltage or less, independent of any fault current contribution from the Asynchronous Generating Facility.
2. An Asynchronous Generating Facility shall remain online for any voltage disturbance caused by a single-phase fault on the transmission grid, or within the Asynchronous Generating Facility between the Point of Interconnection and the high voltage terminals of the Asynchronous Generating Facility's step up transformer, with delayed clearing, plus any subsequent post-fault voltage recovery to the final steady-state post-fault voltage unless clearing the fault effectively disconnects the generator from the system. Clearing time shall be based on the maximum backup clearing time associated with a single point of failure (protection or breaker failure) for any single-phase fault location that

reduces any phase-to-ground or phase-to-phase voltage at the Asynchronous Generating Facility's Point of Interconnection to 0.2 per-unit of nominal voltage or less, independent of any fault current contribution from the Asynchronous Generating Facility.

3. Remaining on-line shall be defined as continuous connection between the Point of Interconnection and the Asynchronous Generating Facility's units, without any mechanical isolation. Asynchronous Generating Facilities may cease to inject current into the transmission grid during a fault.
4. The Asynchronous Generating Facility is not required to remain on line during multi-phased faults exceeding the duration described in Section A.i.1 of this Appendix H or single-phase faults exceeding the duration described in Section A.i.2 of this Appendix H.
5. The requirements of this Section A.i. of this Appendix H do not apply to faults that occur between the Asynchronous Generating Facility's terminals and the high side of the step-up transformer to the high-voltage transmission system.
6. Asynchronous Generating Facilities may be tripped after the fault period if this action is intended as part of a special protection system.
7. Asynchronous Generating Facilities may meet the requirements of this Section A.i of this Appendix H through the performance of the generating units or by installing additional equipment within the Asynchronous Generating Facility, or by a combination of generating unit performance and additional equipment.
8. The provisions of this Section A.i of this Appendix H apply only if the voltage at the Point of Interconnection has remained within the range of 0.9 and 1.10 per-unit of nominal voltage for the preceding two seconds, excluding any sub-cycle transient deviations.

The requirements of this Section A.i in this Appendix H shall not apply to any Asynchronous Generating Facility that can demonstrate to the CAISO a binding commitment, as of May 18, 2010, to purchase inverters for thirty (30) percent or more of the Generating Facility's maximum Generating Facility Capacity that are incapable of complying with the requirements of this Section A.i in this Appendix H. The Interconnection Customer must include a statement from the inverter manufacturer confirming the inability to comply with this requirement in addition to any information requested by the CAISO to determine the applicability of this exemption.

## **ii. Frequency Disturbance Ride-Through Capability**

An Asynchronous Generating Facility shall comply with the off nominal frequency requirements set forth in the WECC Under Frequency Load Shedding Relay Application Guide or successor requirements as they may be amended from time to time.

### **iii. Power Factor Design and Operating Requirements (Reactive Power)**

1. Asynchronous Generating Facilities shall meet the following design requirements:
  - a. An Asynchronous Generating Facility shall be designed to have sufficient reactive power sourcing capability to achieve a net power factor of 0.95 lagging or less at the Point of Interconnection, at the Generating Facility's maximum Generating Facility Capacity. An Asynchronous Generating Facility shall be designed to have net reactive power sourcing and absorption capability sufficient to achieve or exceed the net reactive power range in Figure 1 as a function of the Point of Interconnection voltage, without exceeding the ratings of any equipment in the Asynchronous Generating Facility. The Point of Interconnection voltage is specified in per-unit of the nominal voltage.

### **iv. Supervisory Control and Data Acquisition (SCADA) and Automated Dispatch System (ADS) Capability**

An Asynchronous Generating Facility shall provide SCADA capability to transmit data and receive instructions from the Participating TO and CAISO to protect system reliability. The Participating TO and CAISO and the Asynchronous Generating Facility Interconnection Customer shall determine what SCADA information is essential for the proposed Asynchronous Generating Facility, taking into account the size of the plant and its characteristics, location, and importance in maintaining generation resource adequacy and transmission system reliability.

An Asynchronous Generating Facility must be able to receive and respond to Automated Dispatch System (ADS) instructions and any other form of communication authorized by the CAISO Tariff. The Asynchronous Generating Facility's response time should be capable of conforming to the periods prescribed by the CAISO Tariff.

### **v. Power System Stabilizers (PSS)**

Power system stabilizers are not required for Asynchronous Generating Facilities.



**Appendix I**  
**To First Amended LGIA**  
CONSENT TO ASSIGNMENT